

3M

Cable and Pipe Locating Techniques

for use with 3M™ Dynatel™
Cable and Pipe Locators

Table of Contents

Section 1 The Basics of Cable Locating

1. Introduction	7
2. Applying the Signal: The Direct Connect Method	8
3. Applying the Signal: The Induction Method	9
4. Applying the Signal: The Dyna-Coupler Method	10
5. Other Locating Signal Sources	10
A. Passive Signals	10
B. Power Frequencies	11
C. Radio signals	11
D. Cable TV Signals	11
E. Other Transmitted Signal Sources	11
6. Choosing Trace Modes	12
7. One Touch Gain adjustment	13
8. Locating Techniques	14
A. Sweeping	14
B. Positioning	14
C. Tracing	14
D. Identifying Cable By Depth-Current Measurement	15
E. Tracing Currents	16
9. External DC Power and 5 Watt Output	17
A. External DC Power	17
B. 5 Watt Output	17

Section 2 Telephone Cable Locating Techniques

1. Introduction	9
2. Applying Signal to Telephone Cable: Induction Method	9
3. Applying Signal to Telephone Cable: Direct-connect Method	20
4. Applying Signal to Telephone Cable: Dyna-Coupler Method	21
5. Locating Slack Loops and Butt Splices	23
6. Locating Unknown Laterals	23
7. Locating Cables from Pedestals	24
8. Locating Service Drops	25
9. Locating an Open End	25
10. Identifying Cables	25
11. Pair Identification	26
12. Locating Splits	27
13. Fiber Optic Locating	28
A. Can the Fiber Be Traced?	28
B. Applying the Trace Signal	29
Attaching at CO or Remote Terminal Office	29
Attaching at the Splice Point	29
C. Tracing the Fiber Optic Cable	30

Section 3 Power Cable Locating Techniques

1. Introduction	31
2. Applying Signal to Power Cables: Direct-connect Method	31
A. Applying Signal to the Transformer	31
B. Applying Signal at the Meter	31
C. Applying Signal to De-Energized Secondaries	32
3. Applying Signal to Power Cables: Induction Method	32

4. Applying Signal to Power Cables: Dyna-Coupler Method	33
A. Applying Signal to Primary Cables	33
B. Applying Signal to Secondary Cables	34
5. Identifying Slack Loops	35
6. Identifying A Cable Open End	35
7. Identifying Primary Power Cables	36
8. Locating Open Concentric Neutrals	37
9. Locating Buried Streetlight Cables	38

Section 4 CATV Cable Locating Techniques

1. Introduction	39
2. Applying Signal to CATV Cables: Induction Method	39
3. Applying Signal to CATV Cables: Direct-Connect Method	40
4. Applying Signal to CATV Cables: Dyna-Coupler Method	41
5. Locating Cable Slack Loops	42
6. Locating Cables from Pedestals	42

Section 5 Pipe Locating Techniques

1. Introduction	43
2. Applying Signal to Pipe: Induction Method	43
3. Applying Signal to Pipe: Direct-connect Method	44
A. Direct-connect Method on Tracer Wires	45
4. Apply Signal to Pipe: Dyna-Coupler Method	45
5. Locating Nonmetallic Pipe	46
6. Locating Pipe with Impressed Cathodic Protection	47

Section 6 Locating Faults

1. Introduction	49
2. Locating Sheath Faults	50
A. Locating Sheath Faults Near Pedestals	52
B. Locating Sheath Faults Under Pavement	53
Perpendicular Method	53
Triangulation Method	53
Extended Frame Methods	54
C. Finding a Fault without Tracing the Cable Path	55
D. Multiple Faults	56
3. Locating Aerial Faults	57
4. Locating Earth Faults Near the Meter Box	58
5. Locating Earth Faults in Secondary Cable	58

Section 7 Locating Active Duct Probes

1. Introduction	59
2. Locating the Active Duct Probe	59
3. Determining the Depth of the ADP	61
A. Determining ADP Depth with 500A/573A Cable Locators	62
4. Locating Blockage or Collapsed Ducts	63
5. Locating Sewer Pipe Problems Using a Video Camera	63
6. Locating a Flushing Hose Nozzle	63

This manual has been prepared to provide the most important written instruction material to date for cable locating with 3M's Cable and fault Locating products. It assumes a basic understanding of the commonly used terms in telephone transmission and switching. Whenever this manual is reissued, the reason(s) for reissue will be listed here. Comments concerning the contents or organization of this document, as well as suggestions for improvement are welcomed.

Direct comments to: **3M Telecom Systems Division
Lab - Technical Communications
6801 River Place Boulevard
Austin, Texas 78726-9000**

**For Technical Service call: 800/426 8688
(outside the USA call 512/984 2575)**

Glossary

AC	Abbreviation for Alternating Current.
Amplitude	The maximum value of a varying quantity. A signal on a buried cable will have a certain amplitude which may be different from the signal on another buried cable. The receiver electronics can detect and display the difference.
Attenuated	A general term used to denote a decrease in the magnitude of a signal from one point to another.
Audio	A signal which can be heard by the human ear, typically from about 15 Hz to 15 kHz.
Conductive	Property of a material which allows the passage of a signal or current.
Hz	Abbreviation for Hertz. A unit of frequency equaling one cycle per second.
Induction	A method of putting signal on a buried conductor by using a varying current in one circuit (the transmitter) to produce a voltage in another nearby circuit (the buried conductor).
kHz	Abbreviation for kilo-Hertz. Hertz times 1000; Example: 2.7 kHz equals 2700 Hertz.
k ohm	Abbreviation for kilo-Ohms. Ohms times 1000; Example: 2.5 kohms equals 2500 ohms.
LCD	Liquid Crystal Display.
Megohms	Abbreviation for mega-Ohms. Ohms times 1,000,000. Example: 2.5 megohms equals 2,500,000 ohms.
Mode	Method of operation.
Null	A receiver trace mode where the receiver will respond to signal on a buried cable by indicating minimum signal directly over the cable.
Ohmmeter	Device for measuring electrical resistance.
Peak	A receiver trace mode where the receiver will respond to signal on a buried cable by indicating maximum signal directly over the cable.
Resistance	Property of a conductor which determines the current which will flow through it when a particular voltage is applied. Measured in Ohms.
RMS	Abbreviation for root-mean-square. Used to designate the measurement of a voltmeter when measuring 60 Hz. Example: 110 volts RMS.
Secondary	A cable transmitting approximately 600 volts or less.
Triangulate	A method of finding the location of a point by taking observations at two of the corners of a triangle. The point where the two observations cross is the third corner of the triangle and the target location.
Voltmeter	Device for measuring electrical potential difference.

Section 1 The Basics of Cable Locating

1. Introduction

- 1.1 Cable locating is not an exact science, yet. To do a good job, you must know your equipment, and use your intuition and good judgment. Certain techniques can alert you to potential problems and make the difference between a good locate and a bad one. In this manual, we discuss the basics of locating buried cable or pipe by using a Transmitter to apply a signal to the conductor, and tracing the conductor's path using a Receiver.
- 1.2 There are three methods of applying signal with a 3M™ Dynatel™ Transmitter:
- Direct connect method
 - Induction method
 - Dyna-Coupler method
- 1.3 With any method of applying signal, frequency choice is important to get the “most” signal on the cable. Any signal applied to an insulated, buried cable or pipe leaks off to ground; as it gets farther away from the transmitter, the signal gets weaker and finally disappears. How fast it leaks off is determined by:
- Cable diameter,
 - wet or dry soil conditions, and
 - signal frequency.

Since these conditions vary, the Dynatel Transmitters offer more than one frequency choice:

Low (<10 kHz): These frequencies usually provide the most accurate locate in congested areas (the lower the frequency, the better). They are best for tracing over long distances and do not couple easily to other buried cables. These frequencies are generally too low to be used with the Dyna-Coupler or the induction mode and so the direct-connect method should be used (direct-connect is the preferred method).

Medium (30 kHz - 90 kHz): Medium frequency allows the use of the Dyna-Coupler and the induction mode. Although it will couple to other nearby cables, medium frequency does not do so as strongly as high frequency. Medium frequency travels less far than low frequency but farther than the high frequency. It is best when the Dyna-Coupler or the induction mode is used (when the direct-connect method cannot be used) and the tracing distance is one mile or less.

High (130 kHz - 350 kHz): High frequency attenuates rapidly and so is intended for shorter runs. High frequency will couple strongly to other nearby cables. It will work best with the Dyna-Coupler and the induction mode. High frequency is best for sweeping a large area to locate all buried cables. If the receive signal is weak at the beginning of the trace, first try high power, then a higher frequency.

2. Applying the Signal: The Direct-connect Method

- 2.1 Connecting directly to the cable or pipe you want to trace (power cables only if they can be de-energized) is the most accurate method of cable locating. Connecting the Transmitter directly isolates the signal to one cable.

Danger! *Voltage greater than 240 volts will damage equipment and cause personal injury and death. Make all direct test connections before turning on the Transmitter. Then activate the Transmitter in the Ohms mode and check the display for voltage readings. Follow standard procedures for reducing the voltage.*

- 2.2 Set the Transmitter frequency to a lower frequency (where applicable); low frequencies do not couple to other grounded cables as easily as higher frequencies, and they travel further down the cable.
- 2.3 There are several methods for direct-connecting the transmitter, depending on your application. These may include applying signal to a telephone or CATV pedestal, a power transformer or meter, or directly to the cable or pipe. You can find detailed instructions for your application in later sections of this manual.

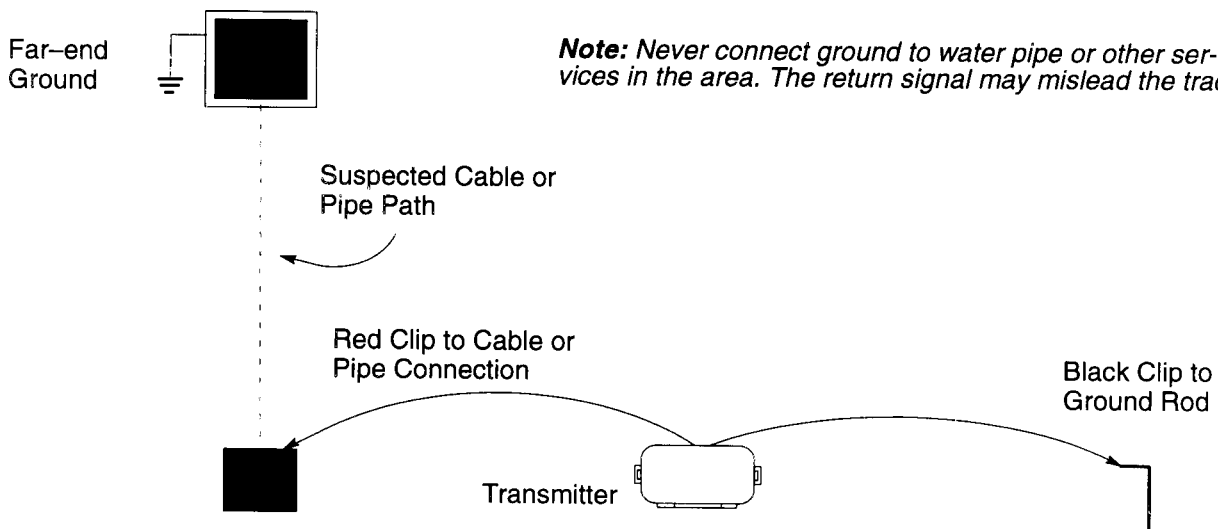

A Few Important Points About Grounding

- 2.4 Grounding can “make or break” a locate when you are using the direct-connect method. The Transmitter connects electrically to the cable or pipe to be located and sends signal current through it. The signal goes to ground at the far-end, and returns to the Transmitter through the ground rod. If the conductor is not well grounded, or if the Transmitter connection to the ground rod is poor, the signal will also be poor and not detectable. The better the ground, the stronger the signal.
- 2.5 Place the Transmitter ground rod as far from the far-end ground and as far from the trace path as possible. In general, this means placing the ground rod at a ninety-degree angle to the suspected path, as shown above. If necessary, you can extend the ground lead with any insulated wire.

3. Applying the Signal: The Induction Method

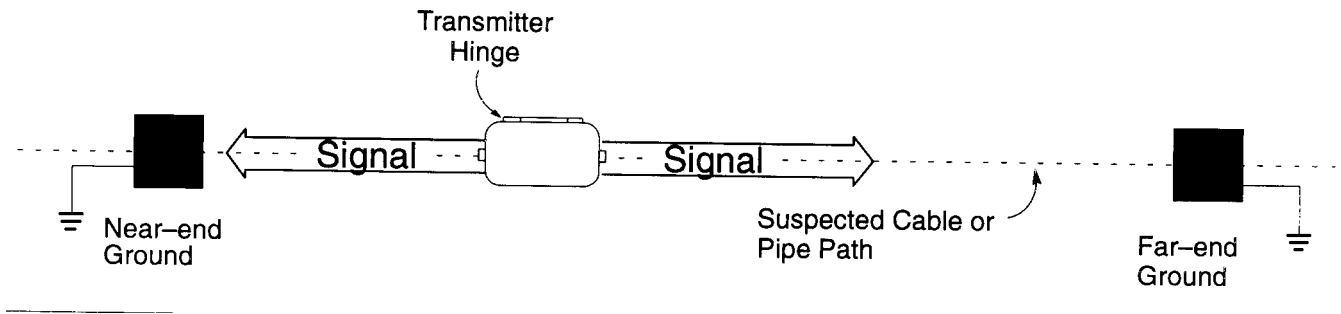

- 3.1 The simplest way to put signal on a buried cable or pipe is with induction, where you merely set the Transmitter on the ground directly over the cable and turn the Transmitter on. The Transmitter induces signal current (tone) into any parallel conductor within range.
- 3.2 It is important to place the unit directly over the cable, with the hinge parallel to the cable path, as shown above. The signal drops off rapidly if you place the Transmitter even 5 or 10 feet to either side of the path.

Note: *In congested situations where services such as gas or water pipes, cable TV, and lawn-watering control circuits are all buried nearby, you should not use the induction method to apply signal. The induction mode applies signal to all nearby conductors and confuses the trace.*

- 3.3 The strength of the induced signal depends on three things: the Transmitter frequency, how well the conductor is grounded, and how deep the conductor is buried.
- 3.4 From the Transmitter, a higher frequency travels farther than lower frequencies and couples to nearby conductors (such as the cable or pipe to be traced). When using the Induction method, set the Transmitter frequency to 33 kHz or higher frequency. Keep in mind that higher frequencies and the high output level setting also put signal on conductors other than the one you are tracing. Also, the Receiver can pick up signal from the Transmitter up to about 50 feet away, even if no cable exists between them. For best results, keep the Receiver away from the Transmitter by at least that distance.
- 3.5 The conductor must be well-grounded at both ends to produce a good locate. In all methods, the better the ground to the conductor, the stronger the signal.
- 3.6 You can find detailed instructions for using the Induction method in your application in later sections of this manual.

4. Applying the Signal: The Dyna-Coupler Method

Note: The coupler jaws must fully close for signal transmission.

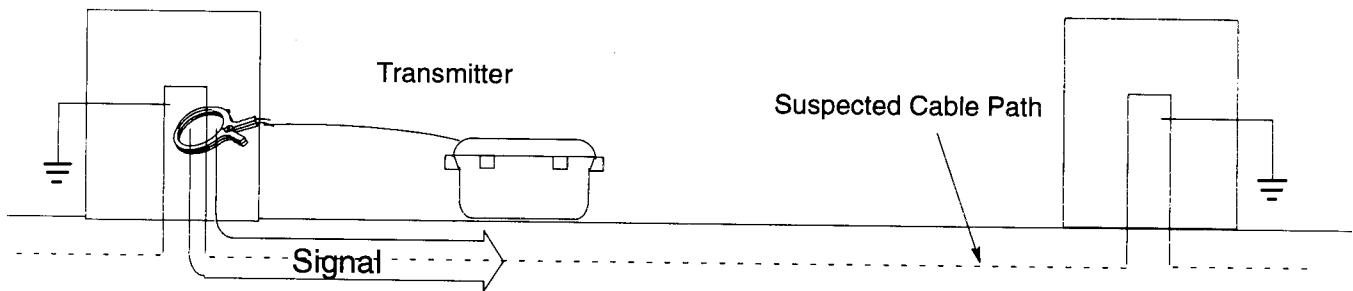

- 4.1 The easiest way to put signal on a cable is with the Dyna-Coupler. When its jaws close around a cable or pipe, the Dyna-Coupler couples the Transmitter signal onto it. As with the other methods, the cable or pipe must be grounded to form a complete circuit path for the signal to follow.
- 4.2 When you apply the Dyna-Coupler between grounds, signal will be on the section between the grounds.
- 4.3 You can find detailed instructions for using the Dyna-Coupler in your application in later sections of this manual.

5. Other Locating Signal Sources

A. Passive Signals

- 5.1 Passive signals are naturally present on many conductors and allow you to locate cables without using the Transmitter. For example, power cables carry 50 or 60 Hz currents. Less obvious are low frequency currents resulting from local broadcast radio transmissions that penetrate the earth and flow along metallic cables.
- 5.2 Passive signals let you locate conductors but not identify them because the same signals may appear on all conductors. Their value is in enabling buried conductors to be detected and avoided using only the Receiver. Be aware that all passive signals may change without notice.
- 5.3 When you plan to excavate to a conductor that has been located and identified with an active signal, you should give the area a passive sweep to check for other nearby lines that are at risk during the excavation. Lines that you locate during a passive sweep can then be traced and identified with an active signal.

B Power Frequencies

- 5.4 An energized cable carrying AC power produces a 50 or 60 Hz signal. Although these are relatively low frequencies, they can still couple into other conductors buried nearby. You can detect the conductor because of the signal, but identification is impossible. The signal could be coming from a power cable, a nearby pipe, or concrete reinforcing bars. However, the knowledge that these conductors exist is useful.
- 5.5 Most energized power cables are easy to detect but sometimes power cables are designed to minimize the strength of radiated signals by twisting the wires so that the 'go' and 'return' current fields cancel each other. These cables are difficult to detect. All Dynatel Receivers detect the 9th harmonic of the 50 or 60 Hz frequency (450 or 540 Hz). The 9th harmonic works especially well with three-phase cables. The fundamental frequency normally cancels in a three-phase installation but the 9th harmonic reinforces, generating a stronger signal to trace. Some Receivers detect the 5th harmonic as well as the 9th. The 9th harmonic is best for most passive power frequency locating, but if the signal is weak or intermittent, the 5th harmonic may be able to help. These harmonics are displayed as low (5th) or high (9th). For 60 Hz the selection on the display would read L60 or H60 and for 50 Hz it would read L50 or H50.
- 5.6 Some Receivers have a selection for the second harmonic of the 50 or 60 Hz frequency (100 or 120 Hz). This passive power frequency is useful for tracing a conductor carrying a rectified AC signal. Such signals are used in impressed cathodic protection systems for pipe. The display will read either 100 or 120 when this frequency is selected.

C Radio Signals

- 5.7 Low frequency radio signals from local broadcast transmitters will cause currents to flow in buried conductors. These signals are then reradiated from the conductor and can be detected by the Receiver. The Receiver frequency should be set to the LF selection (available on E version Receivers only).

D Cable TV Signals

- 5.8 The second harmonic of the NTSC television horizontal scan frequency is detectable by the Receiver at 31.5 kHz. This frequency is coupled onto the cable by the yoke coils of an operating television receiver. The signal is strongest near the TV receiver so it is useful in finding CATV drops. The display of the locator Receiver reads 31 kHz when this frequency is selected.

E Other Transmitted Signal Sources

- 5.9 Some long distance copper or fiber optic cable systems have limited access and may have permanently installed transmitters at strategic locations for use in tracing the cable. If they can transmit 577 Hz, 512 Hz or 560 Hz, the signal can be detected by the Receiver.

6. Choosing Trace Modes

- 6.1 In most cases, you would choose PEAK mode, but for fast or difficult tracing other modes can be handy. The following is a brief description of each trace mode:

PEAK: In this mode, the Receiver speaker volume increases to a maximum as the antenna crosses the cable. It diminishes as the antenna moves away from the cable path. Simultaneously, the bar graph fills from both sides toward the middle as the 'peak' zone is crossed then opens as the midpoint is passed. The numeric strength indicator also increases to a maximum. Peak mode is useful when tracing changes in cable direction because speaker volume falls off rapidly if the antenna handle is not in line with the cable path. In such a case, a sharp turn or bend in the path is indicated.

PEAK with EXPANDER: The expander is used with peak mode to sharpen or enhance the audio response. The effect is to only allow audio response directly over the cable. If the antenna is moved rapidly, the receiver appears to beep as the antenna crosses the cable path. The expander is useful when you wish to rapidly trace a long straight stretch of buried cable and also to precisely trace a turn or change in direction.

NULL: In this mode, the signal is a minimum directly over the cable and is maximum on either side of the cable. The speaker volume and numeric display signal strength correspond to the signal being received. Some receivers have two bar graph response modes. Refer to your Operators Manual for more information.

DIFFERENTIAL: In this mode, the Receiver provides an indication of the relative position of the cable to the Receiver by displaying right or left arrows (the arrow points toward the cable). The bar graph increases to a maximum as the Receiver antenna is moved directly over the cable path. Speaker response is a high warbling tone to the right of the cable path, a low warbling tone to the left, and a solid tone directly over the cable.

SPECIAL PEAK: This mode will increase the signal sensitivity of the Receiver when the signal is too weak for normal tracing. Use special attention when using this mode because it is more susceptible to congestion than the normal peak mode.

***Note:** While tracing cables, keep the Receiver handle in line with the suspected cable path.*

7. One Touch Gain Adjust

- 7.1 It's Simple... No Guessing... No Trial & Error... No multiple presses needed... When using Peak or Null Tracing modes, just press the Receiver Gain-key "once" to automatically adjust the gain and set the bar graph reference point.
- 7.2 Always adjust the Receiver gain only when you are over the target cable and in either Peak or Null mode. If too much signal is indicated by a completely closed bar graph, press the Gain Adjust key once to automatically adjust the gain and set the bar graph reference point. When the bar graph is completely open, it indicates a weak signal. Press the Gain Adjust key once and the gain will be adjusted and a new bar graph reference point will be set.
- 7.3 As you trace cables away from the transmitter, the signal becomes weaker and it is necessary to readjust the gain. Press the Gain Adjust key once and recheck the signal before continuing.

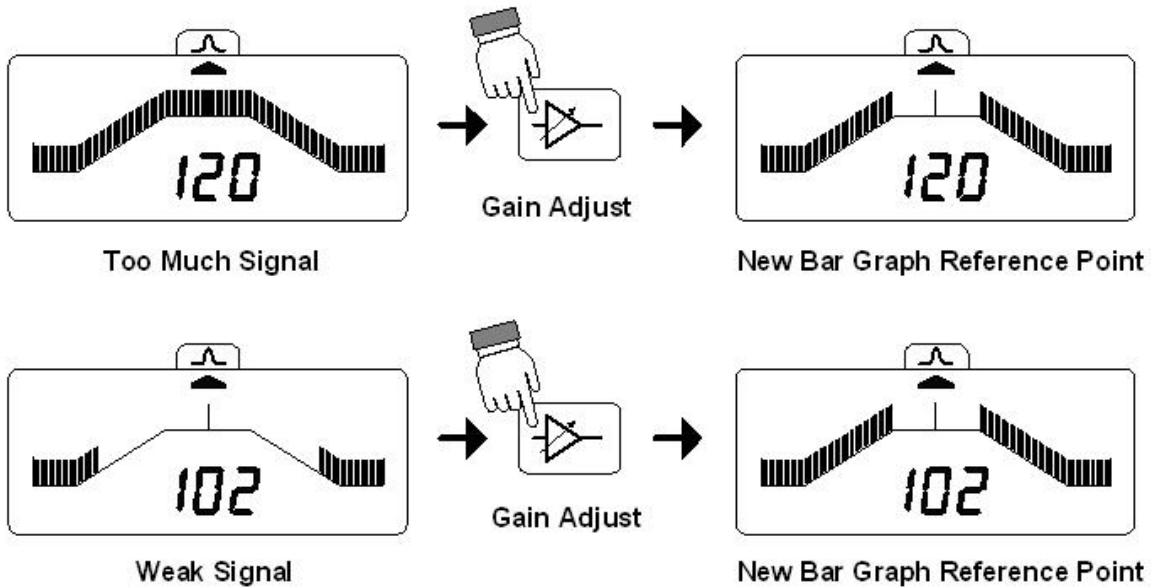

8. Locating Techniques

A. Sweeping

- 8.1 Sweeping an area allows you to locate all buried cable in the area. Use the Induction method to apply the Transmitter signal. Use the highest frequency available so that all cables in the area carry signal. Walk in a grid pattern over the area as shown, and cover the area from two directions. Walk the grid again using the Power mode. Stop the sweep when there is a response. Locate the position of the cable then trace it until you are out of the area, marking the path. After tracing the cable, resume the sweep.

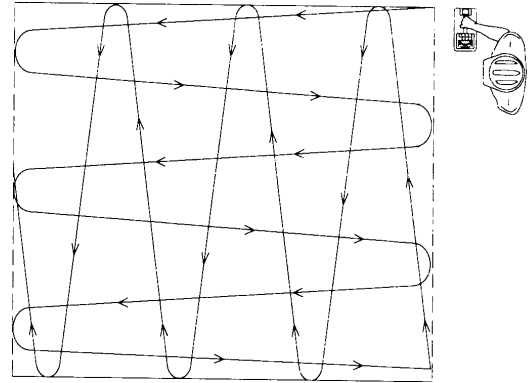

B. Positioning

- 8.2 Positioning is a technique used to quickly find the trace path of a buried cable. The technique can save time when the signal is lost while tracing. Use this technique rather than starting over.
- 8.3 Place the Receiver in the differential mode. Place the antenna on the ground and rotate the Receiver around the antenna as if it were a pivot. Watch the left-right arrows on the display. There is a point where a small counterclockwise rotation lights the right-arrow and a small clockwise rotation lights the left arrow. At this point, note the direction of a line through the Receiver handle. Turn the Receiver 90 degrees from this line (right or left makes no difference). One of the direction arrows is visible. Side step in the direction of the arrow until the Receiver indicates that the cable has been crossed.

C. Tracing

- 8.4 To get the most accurate results when tracing a cable, signal should be isolated to the individual cable. This means using either the direct-connect or Dyna-Coupler methods of applying signal. If surface access is not possible, then use the induction method. Trace the cable at a slow walk while moving the Receiver in a side-to-side motion. Periodically mark the path.
- 8.5 As tracing proceeds, remember that the most powerful signal is near the Transmitter. As the Receiver gets farther away from the Transmitter the signal strength drops off. It is necessary to readjust the gain periodically, to be sure there is adequate signal for the Receiver to operate. Press the GAIN ADJUST key when the bar graph is no longer visible (too little signal) or when the bar graph is closed (too much signal).

D. Identifying a Cable by Depth-Current Measurement

- 8.6 When you apply signal to a cable (using the direct-connect or Dyna-Coupler methods) the signal can travel on all the cables which share ground with your target cable. This can cause trouble with the locate, as a shallow cable with a weak signal can give as good a response as a deep cable with a strong signal.
- 8.7 In the illustration below, transmitter signal was applied to cable 'B' and a strong signal current travels its length. Cable 'A' shares the same ground as cable 'B' and now carries the same signal, but the signal current is greatly reduced. Since cable 'A' is shallow (about one foot), it gives a strong signal response even though the deeper cable 'B' carries more signal current. To identify which response comes from cable 'B', find the strongest response over each cable and press the depth key. During depth measurements, the auxiliary numeric indicator indicates the strength of the signal current in the cable. The cable with the most current is the target cable. Don't forget to also check the depth readout. Most CATV cables are buried one foot or less. Telephone cables are buried at three feet. Power cables and gas pipes are at four feet.

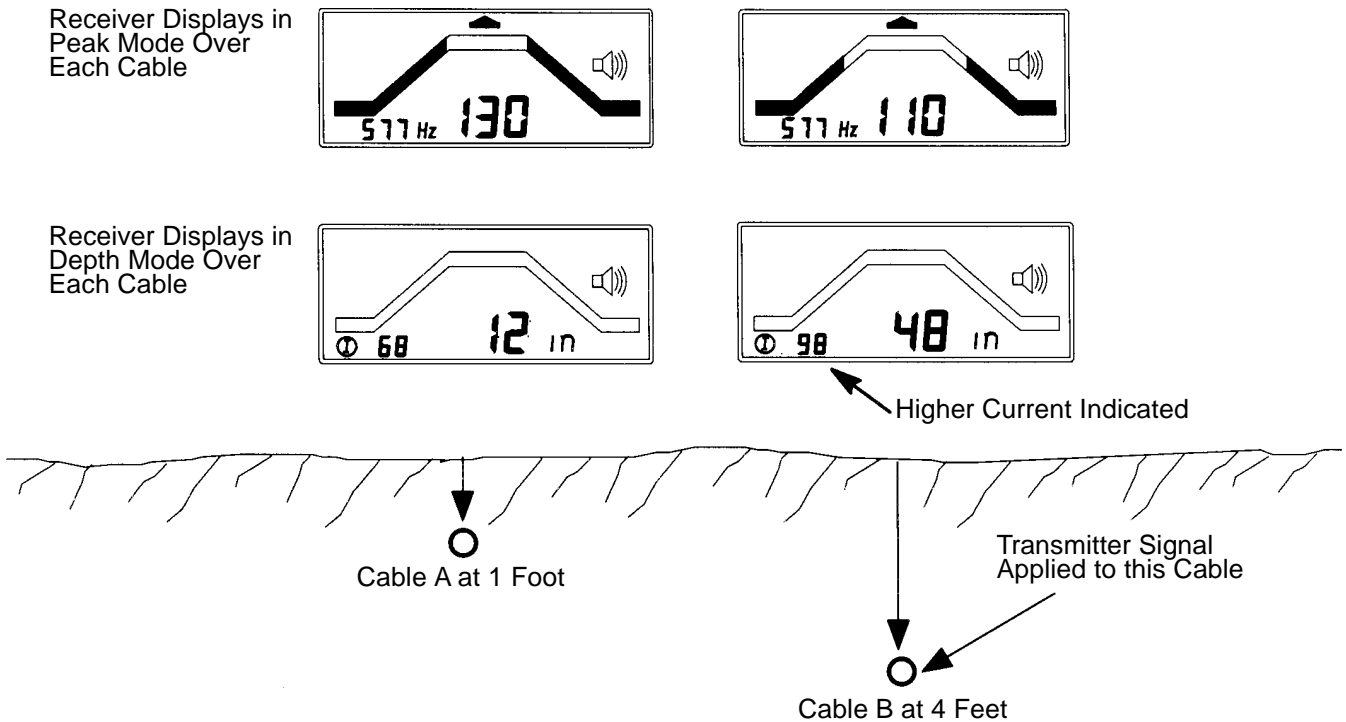

- 8.8 Imagine this problem: You know you have two cables with the same signal and just when you think you've got the target cable identified, the two cables cross. Again, you can use the depth-current measurement to identify the target cable. When cables 'A' and 'B' cross, they change depth. This is not unusual and is often the case. Since the Receiver's signal response varies with depth, it may be difficult to identify the cables using signal level alone. However, the signal current in the cables will not change, and you can compare the bar graph reading in depth mode to identify the cables.

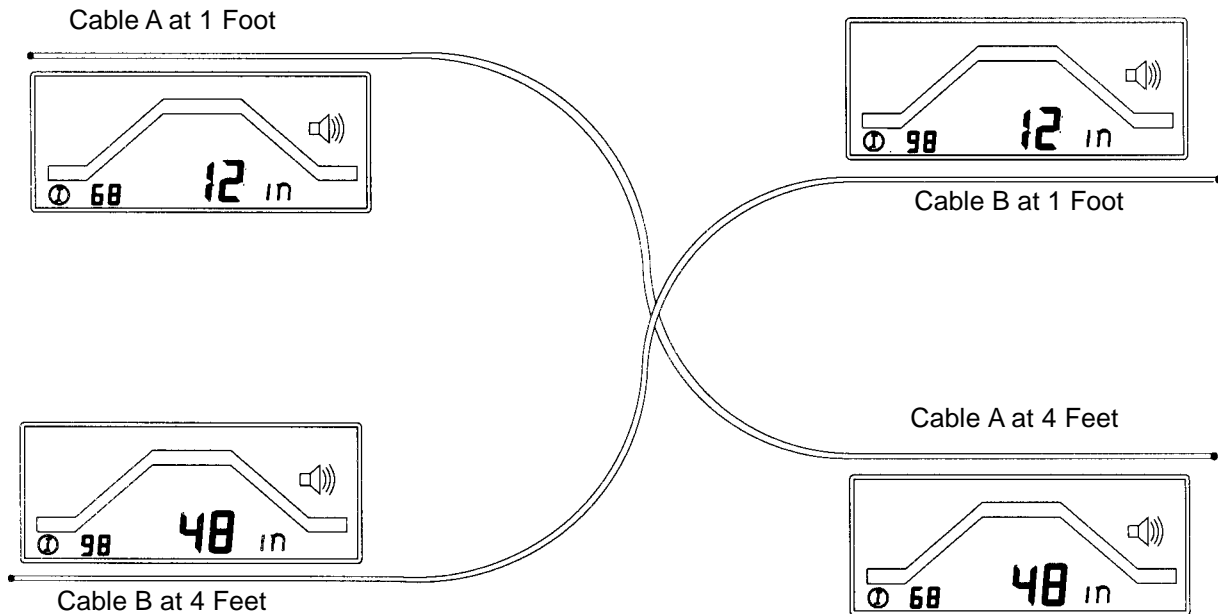

E Tracing Currents

- 8.9 Some Transmitters and Receivers will display cable current. These current indications can be used to select a trace frequency, identify the correct cable, or troubleshoot the set up.
- 8.10 When using the direct connect method, if the Transmitter output current number in the display reads LO, or is a number less than 50, it indicates that the tracing signal is too weak. A number higher than 70 represents a strong tracing signal. Maximize the current number by changing the frequency. Every ten units on the current display represents a factor of two in current magnitude in the cable.
- 8.11 When the Receiver is used to find the cable near the Transmitter connection point, the current number displayed in the Receiver should correspond (within ± 5 points) to the Transmitter number. You must be over the correct cable, and the signal must not be split between two or more cables.
- 8.12 When the Transmitter signal is applied using the Dyna-Coupler, the Transmitter display indicates the current in the coupler and not in the cable. In order to get a measure of the cable current, point the Receiver at the exposed cable about two feet from the Dyna-Coupler. This will be the current number that should be used to identify the correct cable. In general, when the Transmitter is set up to apply more current on the target cable than any other cable, the target cable can be easily identified because the Receiver current reading will be highest.
- 8.13 Since some of the signal in a cable bleeds into the earth, it is expected that the Receiver current indication along the cable will decrease gradually as you move away from the Transmitter. This effect is more pronounced at higher frequencies.

9. External DC Power and 5 Watt Output

A External DC Power

- 9.1 Dynatel Transmitters with option A can be operated from an external 12VDC source as well as its internal batteries. A cigarette lighter adapter-cable is supplied to connect the DC power from a vehicle's battery to the Transmitter's external power connector located next to the output connector. This lets you save the internal batteries by using an external power source or continue operating when the internal batteries are discharged. The internal batteries do *not* recharge when an external DC voltage is applied to the Transmitter's external power connector.

B 5 Watt output

- 9.2 Dynatel Transmitters with option A are capable of 5-watt output as well as the normal 3-watt output. An external DC source is required for 5-watt output. Use the higher output when a very long trace is required. The higher output should also be used on any continuously grounded cables such as lead shielded cables or non-jacketed concentric neutral cables.

Section 2 Telephone Cable Locating Techniques

1. Introduction

- 1.1 Read Section One of this manual to learn more general information about each of the following signal application methods. The following paragraphs provide specific instruction on applying signal for telephone cable locating.

2. Applying Signal to Telephone Cable: Induction Method

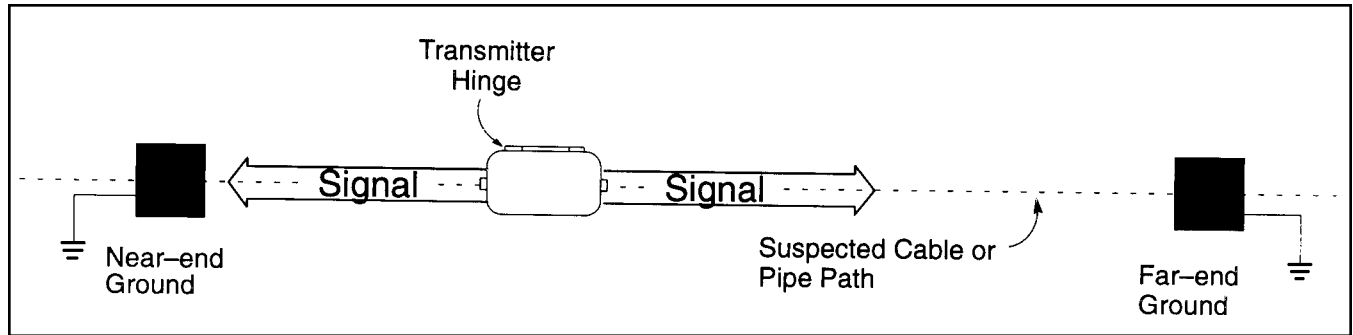

- 2.1 The Induction method broadcasts signal into an area. No access to the cable is necessary. Use this only when there are no other buried conductors present, or when locating all conductive buried services in a general area.
- 2.2 Place the Transmitter on the ground over the cable to be located. The Transmitter hinge should be in line with the cable path, as shown above. Be certain that the Transmitter is directly over the cable to be located.
- 2.3 Turn the Transmitter on and choose 33 kHz signal or higher.
- 2.4 Use the Receiver to test the signal level by placing the Receiver 50 feet away from the Transmitter on the ground near the cable. Move the Transmitter back and forth across the path. Listen for the strongest signal from the Receiver. If the Receiver has trouble picking up the cable path, return to the Transmitter and switch to a higher frequency. If the higher Transmitter frequency will not give satisfactory Receiver response, then boost the Transmitter output as instructed in the unit's Operating Instructions. You can also increase the response by placing the Transmitter on the located position over the cable (50 feet away from the Transmitter's previous position).

3. Applying Signal to Telephone Cable: Direct Connect Method

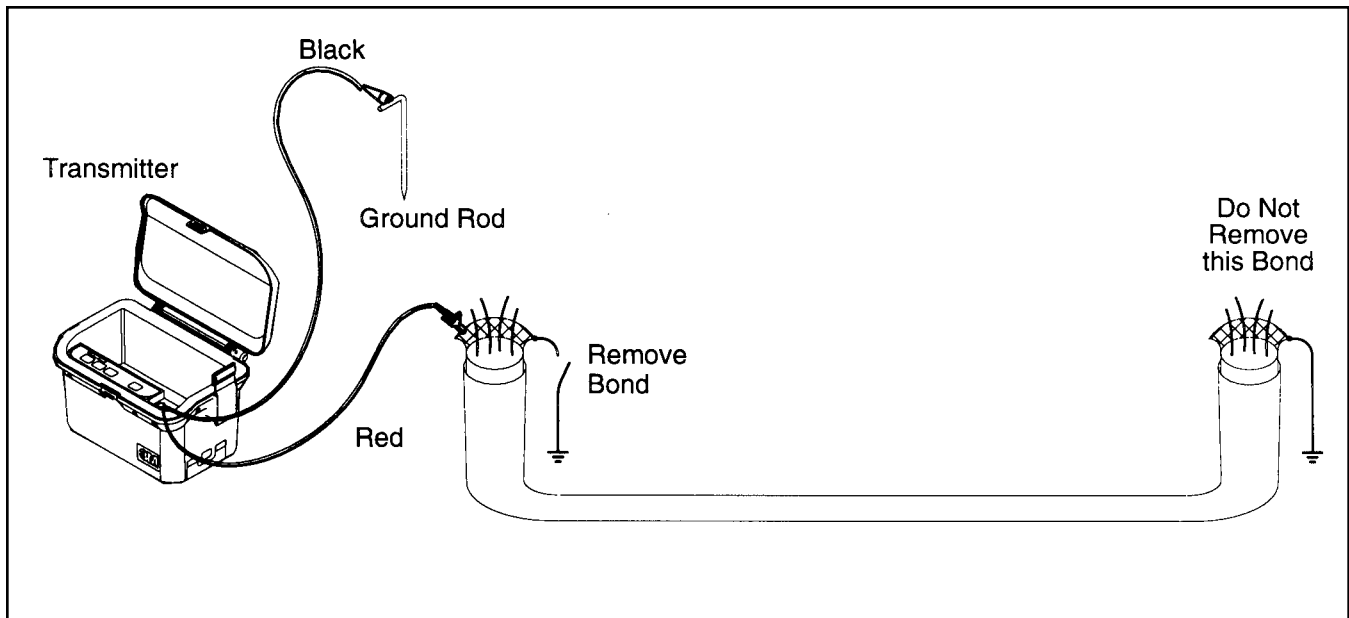

- 3.1 The direct-connect method requires access to the cable shield. Disconnect the cable at the near-end where the Transmitter is connected. Do not disconnect at the far-end since this supplies a far-end ground.
- 3.2 Connect the red lead of the Transmitter to the cable shield and the black lead to the ground rod.

Warning! Potential for electrical shock exists when handling connecting cables while the Transmitter is in the Fault or Tone modes. Turn the transmitter off before handling connecting cables.

- 3.3 Place the ground rod as far away from the cable path as possible (90 degrees from the suspected cable path). Never ground to water pipe or other services in the area. The returning signal on these services may mislead the trace.
- 3.4 Remove the ground bonding at the near-end. The far-end should have a good ground. Turn the Transmitter on and choose the 577 Hz frequency to get greater signal distance down the cable.

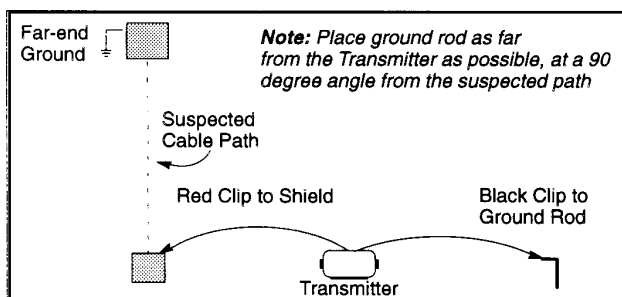

4. Applying Signal to Telephone Cable: Dyna-Coupler Method

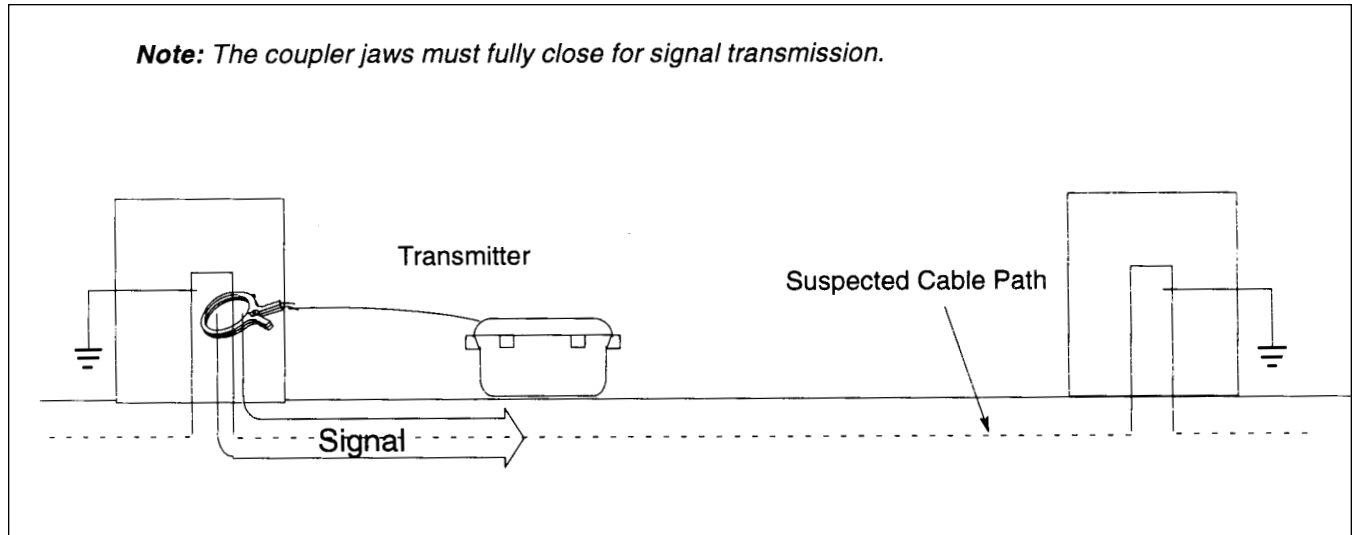

4.1 The Dyna-Coupler puts signal selectively on a cable by clamping around it. This eliminates the need to disconnect the cable. Do not use the Dyna-Coupler on a cable that has the shield ungrounded at both ends.

4.2 Place the Dyna-Coupler on the cable between the ground bonding and the point where the cable enters the earth as shown (A). Note that if you place the Dyna-Coupler above the bond, the signal travels to ground, and not onto the cable.

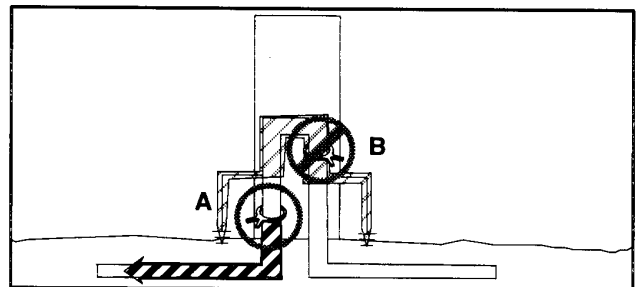

4.3 On short cables, such as service drops, do not use the Dyna-Coupler on an ungrounded end (C). It works better on the grounded end (D). If possible, ground end (C); if not, be sure to use the highest frequency possible.

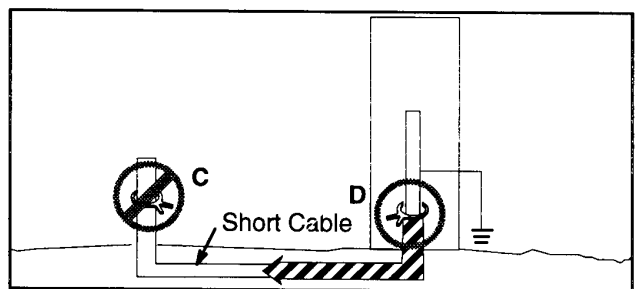

Note: Always use the high output level when using the coupler.

- 4.4 If the cable is long, remove the bonding and signal goes both ways as shown.

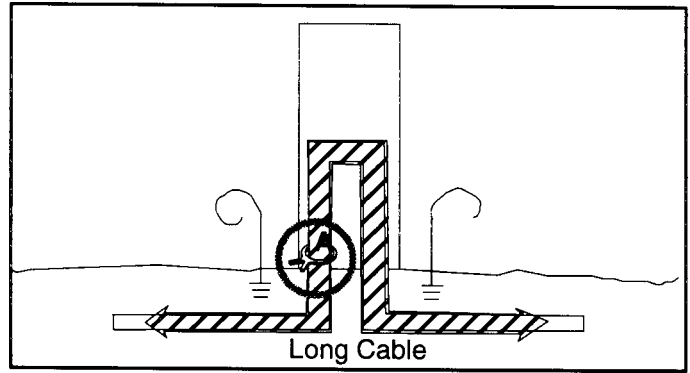

- 4.5 Clamping the Dyna-Coupler to a cable with drop lines or laterals puts full signal on the cable until the junction point. The signal may split evenly at the lateral as shown. When tracing, the speaker volume and signal level indication drops when the Receiver passes the junction. This is an easy way to find laterals.

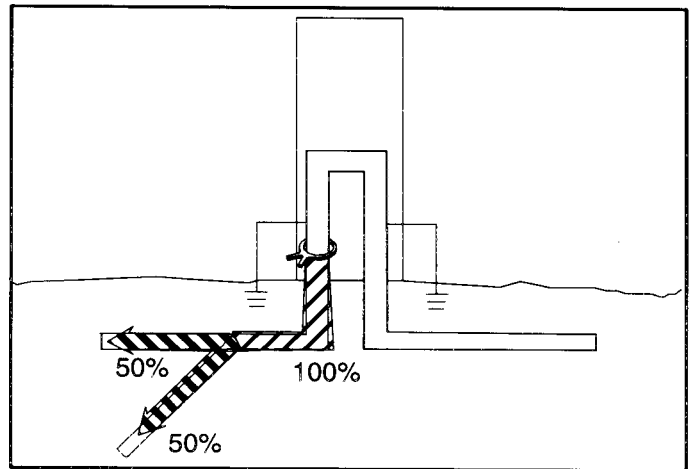

- 4.6 Several cables grounded at a common point present no problem for the Dyna-Coupler method. Even though signal is coupled into each cable, the cable with the Dyna-Coupler is clearly identifiable because it has the strongest signal.

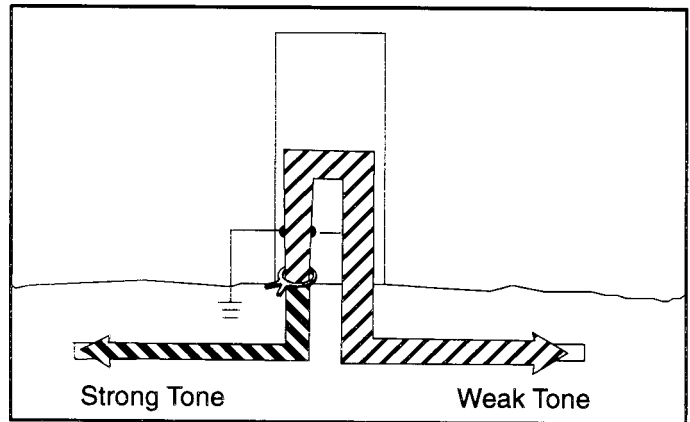

5. Locating Slack Loops and Butt Splices

- 5.1 To identify the presence of a slack loop or butt splice in a cable path, first locate and mark the cable path.
- 5.2 Find the strongest response over the marked cable path and reset the gain.
- 5.3 Retrace the cable path with the Receiver held so the handle is perpendicular to (across) the cable path, as shown. When the Receiver passes over a slack loop or butt splice, the signal increases and the bar graph closes. Mark each response. Whenever you encounter such a condition, check to see if an unknown lateral exists.

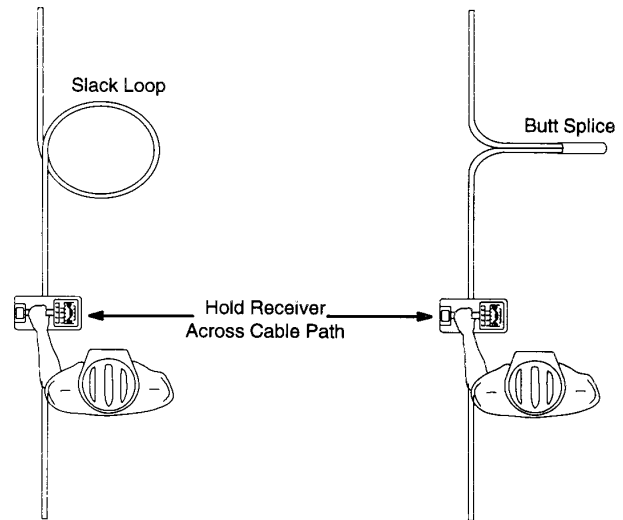

6. Locating Unknown Laterals

- 6.1 To check for unknown laterals which may radiate from a butt splice type or closure, first trace and mark the cable path. Retrace to locate any butt splices or slack loops. Mark the spot of any detected butt splices or slack loops.
- 6.2 If the Receiver gain has not been set while performing the normal trace, go to the marked trace path and pinpoint the path. Reset the gain.
- 6.3 Walk 10 to 25 feet off the trace path and away from the marked butt splice or slack loop. Hold the Receiver so that the display end of the handle points directly to the mark. Walk in a circle around the mark with the Receiver handle pointing to the mark.
- 6.4 The Receiver remains relatively quiet until it crosses a lateral or the actual cable path. Since there could be several laterals radiating from the closure, mark each occurrence of signal around the circle. After you locate each lateral, trace and mark its path.

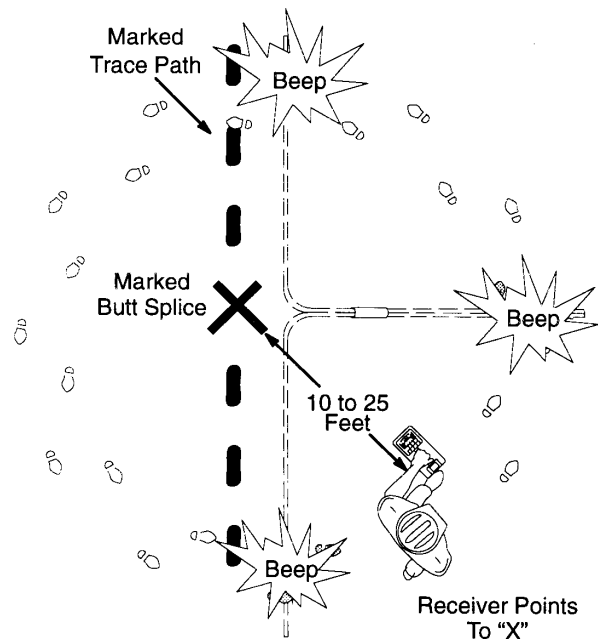

7. Locating Cables from Pedestals

- 7.1 To locate a single cable path from a pedestal, follow these steps:
- 7.2 At the pedestal, apply tracing signal on the target cable using the Dyna-Coupler method. If the header in the pedestal is not grounded, use the ground rod and ground extension cable to ground it.
- 7.3 Walk 10 to 25 feet away from the pedestal. Hold the Receiver so that the display end of the handle points directly to the pedestal. Start walking in a circle around the pedestal with the Receiver always pointing toward the pedestal.
- 7.4 The Receiver remains relatively quiet until it crosses a cable. Stop when there is a response. Find the point of strongest signal and press gain. Check the numeric display for relative signal strength. Remember the number and continue walking the circle. As you walk away from the cable, the signal drops. Press gain and continue. When you encounter another response, find the point of strongest signal. If the greatest signal strength is more than 25 points higher than the others (if any found), then that is the target cable. If the signal levels are closer, then measure the depth of each cable found and note the bar graph in the depth mode (this is a relative measurement of the current flowing in the cable). In the depth mode, the cable that shows at least two more segments on the bar graph than the other cables is the target cable.

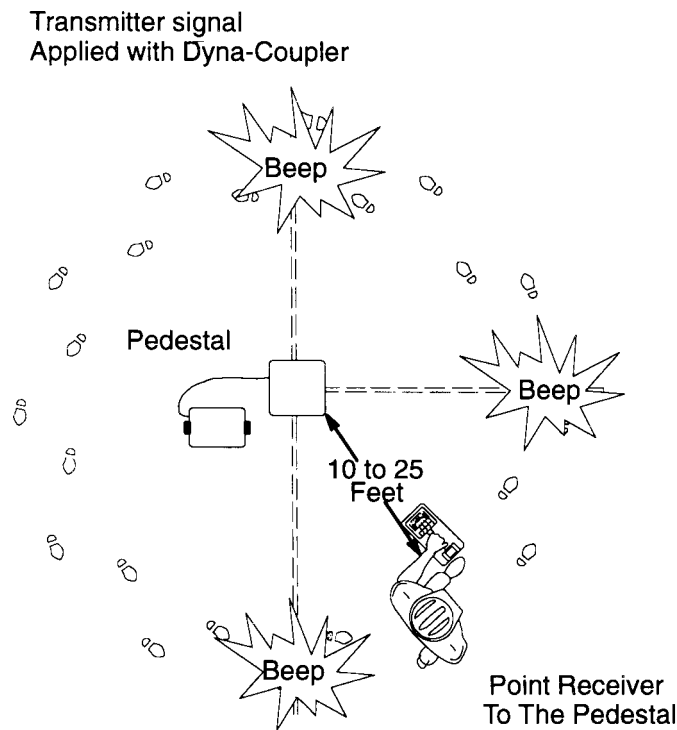

8. Locating Service Drops

- 8.1 When locating the path of a service drop from a house or other building, it is more convenient to apply signal at the house or building. Connect the Transmitter using the direct-connect method. Use the standard tracing techniques described earlier.

9. Locating an Open End

- 9.1 To locate an unterminated or open end of a cable or drop, follow these steps.
- 9.2 If the cable is bonded to ground at the access point, connect the Transmitter using the Dyna-Coupler method. Otherwise, if the cable is not bonded to ground at the access point, connect the Transmitter using the Direct-connect method. With either method, choose the highest frequency available, at high level.
- 9.3 Trace the cable path. The receiver's response decreases suddenly at the site of the clear or severed end.

10. Identifying Cables

- 10.1 This procedure identifies a single cable in a group of similar cables. At an access where cable identity is known, use the Transmitter to put signal on the sought cable with the Dyna-Coupler. Select the highest frequency available. Output level should be set to high. It is not necessary to remove any bonds or ground. At an access at the far-end of the cable group, connect another Dyna-Coupler to the Receiver with the Extension Cable. On the Receiver, select the PEAK trace mode. Select the same frequency as the Transmitter. Check the first cable in the group by clamping the Dyna-Coupler around the cable. Press the GAIN ADJUST key and observe the numeric display, which is relative signal strength. Remember the number and continue by clamping the Dyna-Coupler around the next cable in the group. If the signal strength is greater than the previous observation, press the GAIN ADJUST key. If the signal strength is less than before, ignore it. After checking all the cables in the group, the cable with the highest reading is the one being sought.

11. Pair Identification

- 11.1 This procedure identifies individual conductors within the same cable. It uses the Dyna-Coupler, so none of the pairs will need to be cut. The use of the high frequency will also allow tagging of conductors in a wet pulp section.
- 11.2 At a splice or access, use the Transmitter to put signal on the pair to be identified using the Dyna-Coupler. To minimize signal canceling and disruption on active pairs, clamp the Dyna-Coupler around both tip and ring of the pair and make sure it is fully closed. Place the transmitter in the tone mode and select the highest frequency. If your Transmitter does not have this feature, the highest frequency trace mode will also work.
- 11.3 Take the Receiver and Inductive Probe to the location where identification is needed. Connect the Inductive Probe to the Receiver using the 6-ft. Probe Cable. Both the probe and the cable are available as optional accessories. Select the same mode and frequency as the Transmitter.
- 11.4 Insert the Probe into the bundle of pairs (or the group, if known) and press the GAIN ADJUST key. Next, divide the pairs into two bundles and insert the Probe into each of the bundles and observe the numeric display. The bundle with the highest reading will contain the sought pair. Continue by dividing the bundle with the sought pair into two parts and checking each part for the highest signal. In this way the sought pair will be isolated.

Note: There is a groove around the inductive Probe to indicate the location of the sensing coil. The coil is oriented so that maximum signal will be sensed when the probe is perpendicular to the cable conductor.

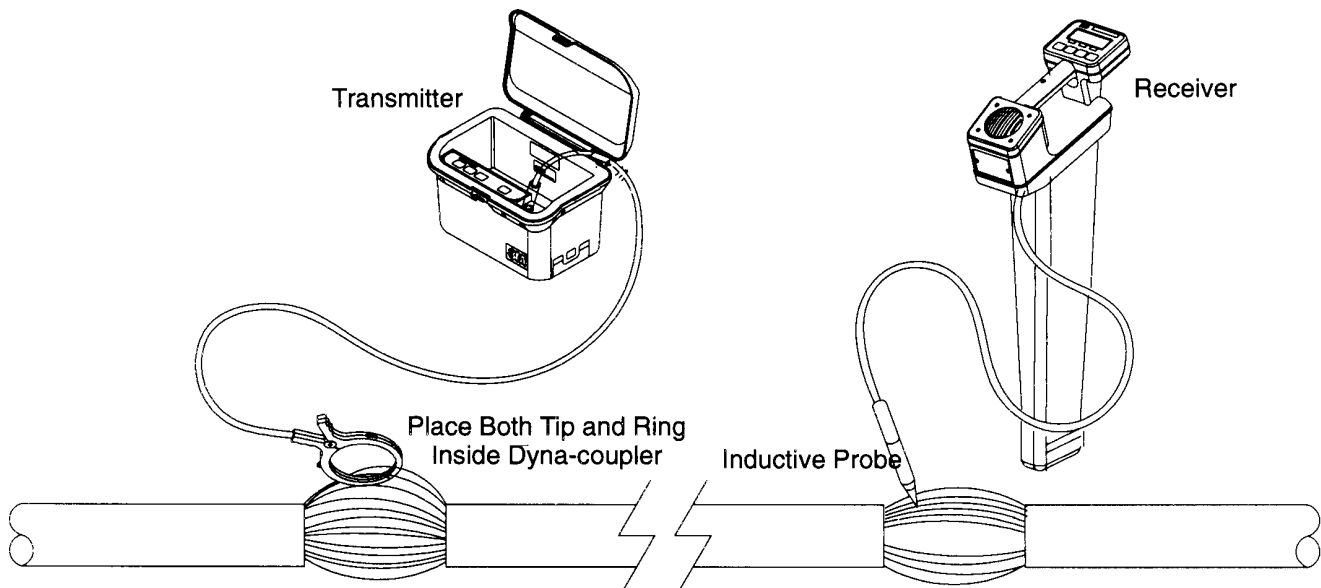

12. Locating Splits

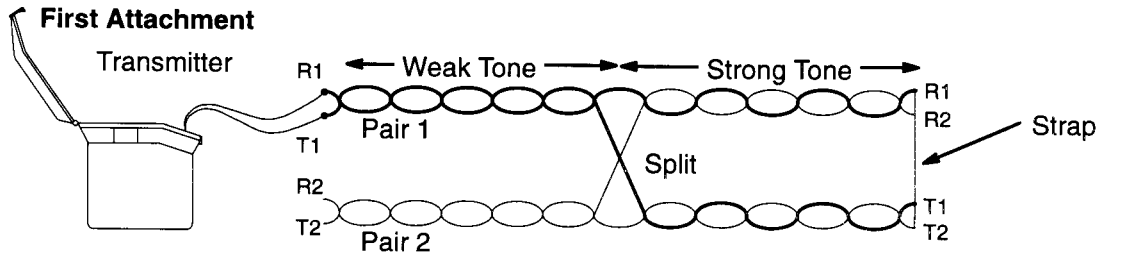

Second Attachment

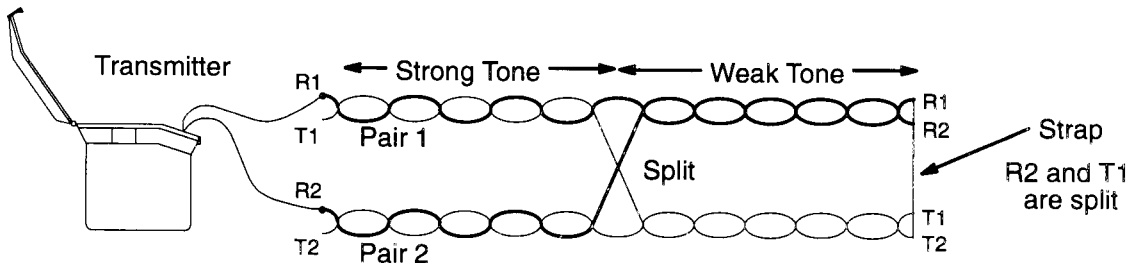

- 12.1 To locate the splice where a split occurs, attach the Transmitter to tip and ring of one pair of the split. Strap the tips and rings of both pairs at a far-end access beyond the splice.
- 12.2 On the Transmitter, select the tone mode and the low frequency.
- 12.3 Using either the Receiver, a toning amplifier or a toning coil, detect a weak tone from the Transmitter to the split, and strong tone from the split to the strap.
- 12.4 To verify that the split has been located, attach the Transmitter to a non-split conductor of one pair and a split conductor of the other pair. The tracing tone is strong from the Transmitter to the split, and weak from the split to the strap.

13. Fiber Optic Locating

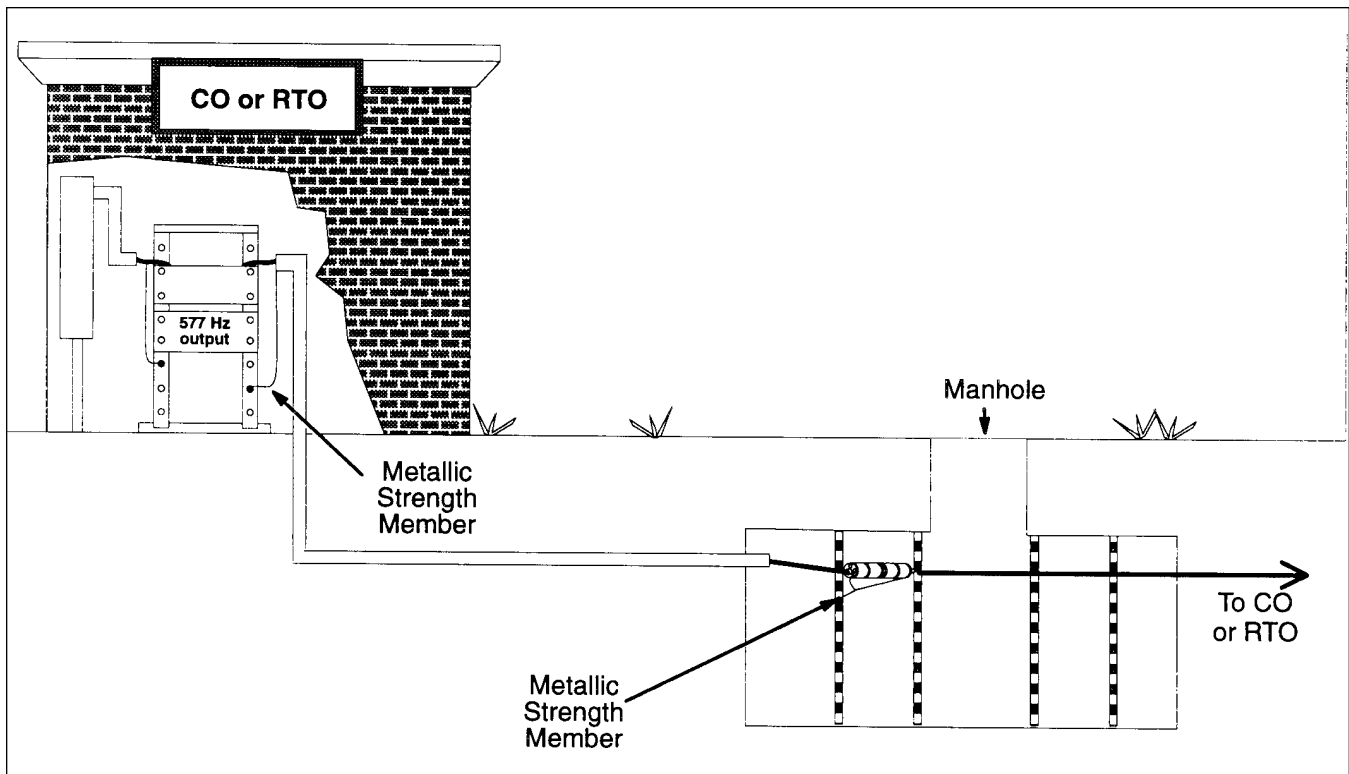

A. Can the Fiber Be Traced?

- 13.1 Fiber optic cables consist of fragile optical fibers encased in a strengthened outer member. The internal sheath of the cable may or may not be metallic. If it is not metallic, the manufacturer may include a metallic strength member (wire) within the sheath. Some fiber optic cables have no internal metal structure, in which case the contractor installing the cable may pull an insulated wire through the underground duct with the fiber optic cable. If a metallic conductor is not in or next to the fiber optic cable, you cannot trace the cable path. You must then rely on site plans for physical location.
- 13.2 You normally find underground fiber optic cable installed in a duct, or a tube within the duct. The installation is normally made from a central office to a remote terminal office or distribution point. There may be several splice points in hand holes or manholes along the route. Installation practices generally require that the fiber optic cable metallic sheath or strength member be grounded at the terminating ends. Bonding practices at the splice points vary by company. Therefore, the metallic strength member may or may not be grounded or may be grounded through a remotely-actuated relay or a voltage transient suppression device. Some installations include a permanently installed rack-mounted transmitter that can selectively place a tracing signal on one of several fiber optic cables. If this transmitter produces a 577 Hz signal, you can trace the fiber optic cable using the Dynatel Receiver.

B. Applying the Trace Signal

- 13.3 If the office installation includes a rack-mounted transmitter, check to see if your Receiver has the same frequency. Some Receivers will receive 512 Hz and 560 Hz as well as 577 Hz. To use the transmitter, attach it to the sheath or strength member of the fiber optic cable to be traced and turn it on. If the transmitter frequency does not match the Receiver, or a rack-mounted transmitter is not available, attach the Dynatel Transmitter at the CO/Remote Terminal Office, or at an intermediate splice point.

Attaching at CO or Remote Terminal Office

- 13.4 To attach the Transmitter at the Central Office or Remote Terminal Office, bring it to the location in the office where the fiber optic cable strength member is grounded. Typically, this is near the rack-mounted digital conversion equipment. Locate and disconnect the metal strength member from the frame or rack ground point.
- 13.5 Check the resistance using the ohms mode. Relatively high resistance (greater than 2 k ohms) means there may be an open between this connection point and the ground at the terminating end or intermediate splice points. If the resistance is very low (less than 250 ohms), there may be another ground point on the strength member within the CO. Either condition probably causes very little of the signal to be placed on the fiber optic cable outside. An acceptable condition is a resistance reading between 250 ohms and 2 k ohms.

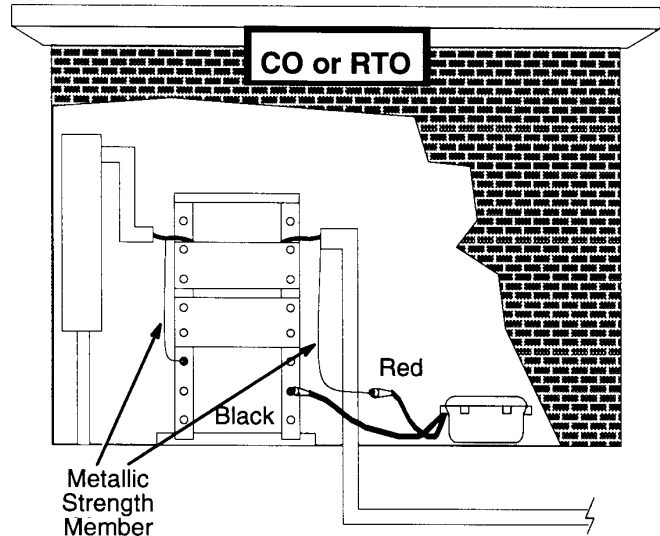

Attaching at the Splice Point

- 13.6 To attach the Transmitter at a field splice point, access the splice case. If the splice case has one or two metal straps connected to ground, you can attach the Transmitter at this location.
- 13.7 If the splice case has two straps, one of them most likely attaches to the metallic sheath or strength member on the incoming side and the other strap attaches to the outgoing side. This lets you connect the Transmitter to the incoming or outgoing side. The two straps may also be connected inside the splice case.

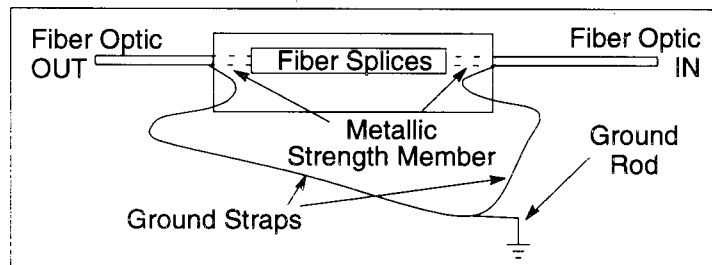

13.8 Maximum tracing signal is obtained by disconnecting the bonding strap(s) from the ground point before attaching the Transmitter, but local practice may not allow this. In this case, the signal splits between the incoming cable, outgoing cable, and the ground point, thus reducing the tracing range.

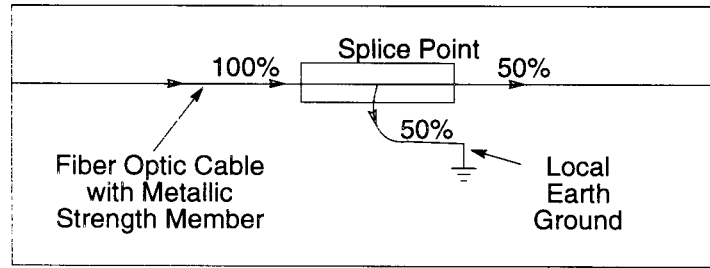

13.9 Use high level output if tracing fiber optic cable longer than .5 miles.

C. Tracing the Fiber Optic Cable

13.10 When tracing from a CO or Remote Terminal office, move to the cable's expected exit point outside the building. Select the same Receiver frequency as the Transmitter.

13.11 Search the area until the unit receives the signal. When tracing at a manhole or hand hole, walk in a circle around the hole with your back or front toward the hole. Move toward increasing signal strength, adjusting Receiver gain as needed until you locate the cable. Trace the path of the cable.

13.12 When tracing a cable over a long distance, the signal strength decreases. This can be caused by the signal "bleeding" off into the earth due to capacitance or by additional grounds at splice points along the fiber optic cable. The "bleeding" effect causes a gradual reduction in signal strength as the Receiver moves along the cable. The splice point ground causes an abrupt or distinct drop in signal because the signal is split between the outgoing fiber optic cable and the local ground. These intermediate ground points can severely limit the tracing distance unless you use a high-powered Transmitter. This abrupt drop in signal is a good indication of the presence of an earth ground at a splice point.

Section 3 Power Cable Locating Techniques

1. Introduction

- 1.1 Read Section One of this manual to learn more general information about each of the following signal application methods. The following paragraphs provide specific instruction on applying signal for power cable locating.

Danger! Voltage greater than 240 volts will damage equipment and cause personal injury and death. Make all direct test connections before turning on the Transmitter. Then activate the Transmitter in the Ohms mode and check the display for voltage readings. Follow standard procedures for reducing the voltage.

2. Applying Signal to Power Cables: Direct Connect Method

- 2.1 There are several possibilities for direct-connecting the Transmitter to apply signal, including applying signal to the transformer, meter, and cable to be located.

A. Applying Signal to the Transformer

- 2.2 The transmitter signal can be applied to all neutrals (both primary and secondary) that are grounded at the transformer by simply connecting the Transmitter to the transformer cabinet. There is no need to open the transformer or to de-energize any of the cables. However, all the neutrals are carrying signal and it may be difficult to identify a single cable.

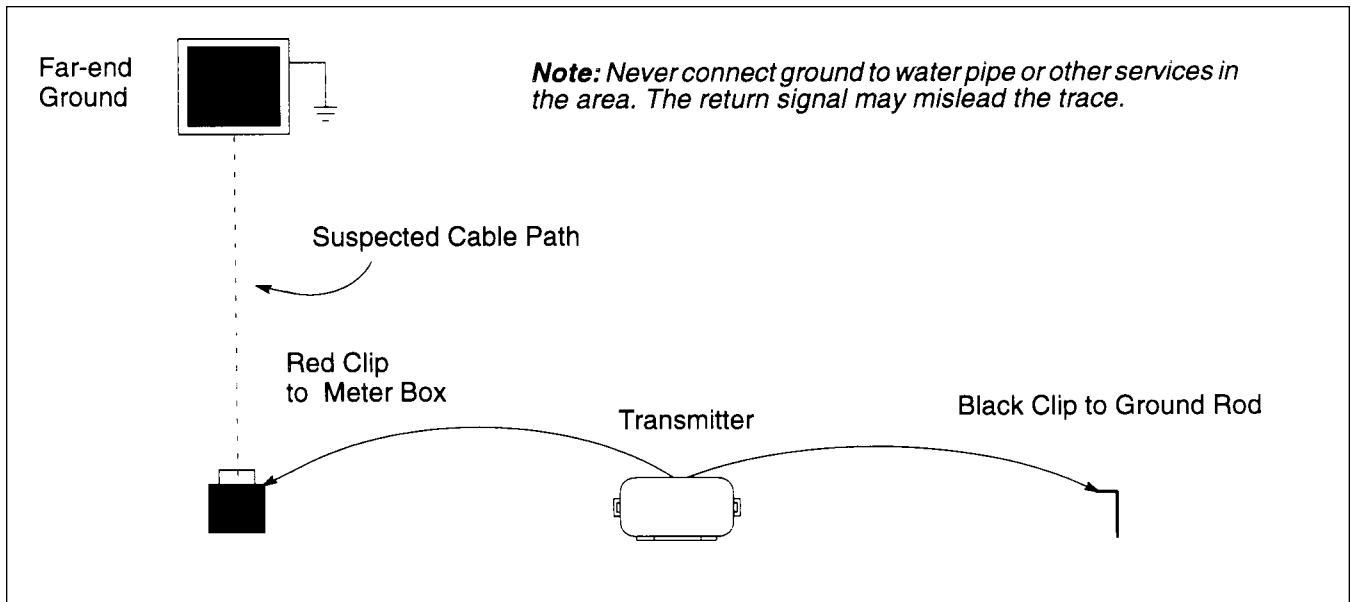

B. Applying Signal at the Meter

- 2.3 Since the secondary neutral connects to ground at the meter as well as the transformer, you can locate energized secondary cables by connecting the Transmitter directly to the meter box. The meter box is the preferred point to apply signal because the transformer usually has better grounding to earth than the meter. The locating signal is weaker if applied at the transformer.
- 2.4 You must place the Transmitter ground rod as far away from the meter ground as possible. If necessary, extend the ground lead with insulated wire. This technique is fast since you do not have to open the transformer, or break the meter seal. Select the lower frequency; it does not couple to other grounded cables as easily as a higher one.

C. Applying Signal to De-Energized Secondaries

- 2.5 On de-energized cables with the far-end grounded, connect the Transmitter directly to the center conductor of the cable to isolate signal to that one cable. Use the direct-connect method as shown to apply signal.

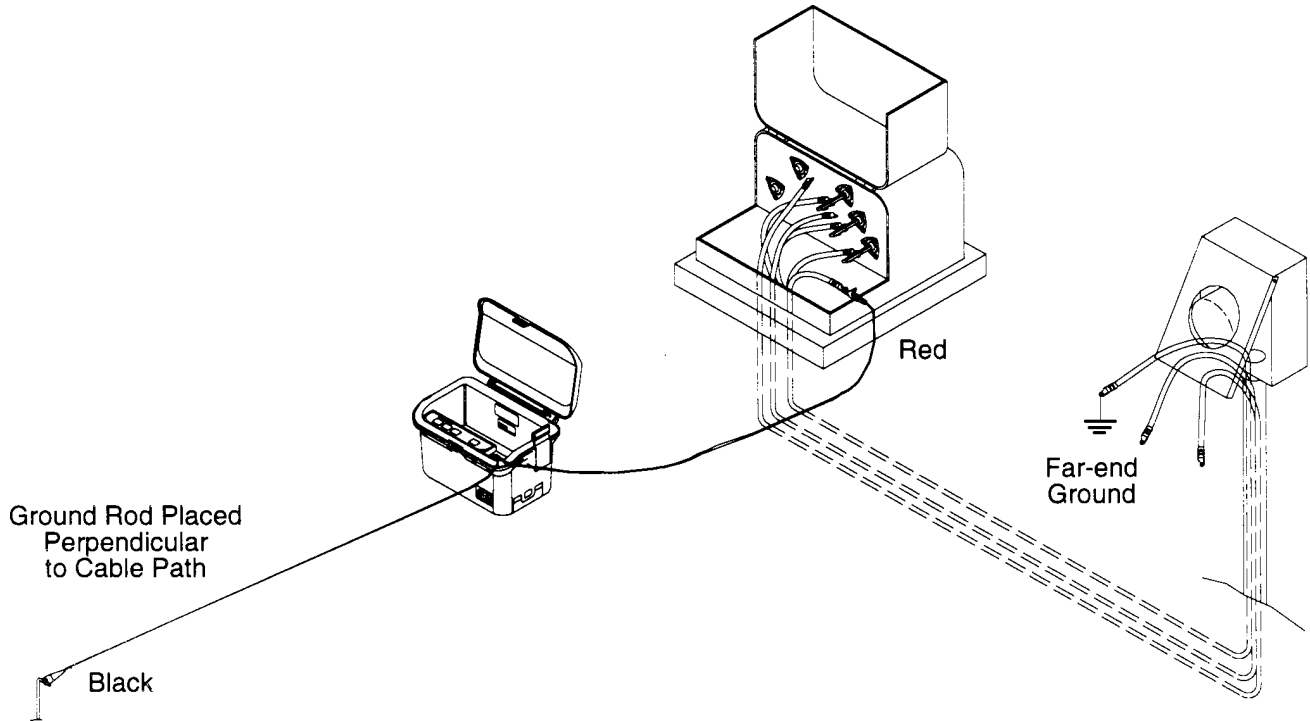

3. Applying Signal to Power Cables: Induction Method

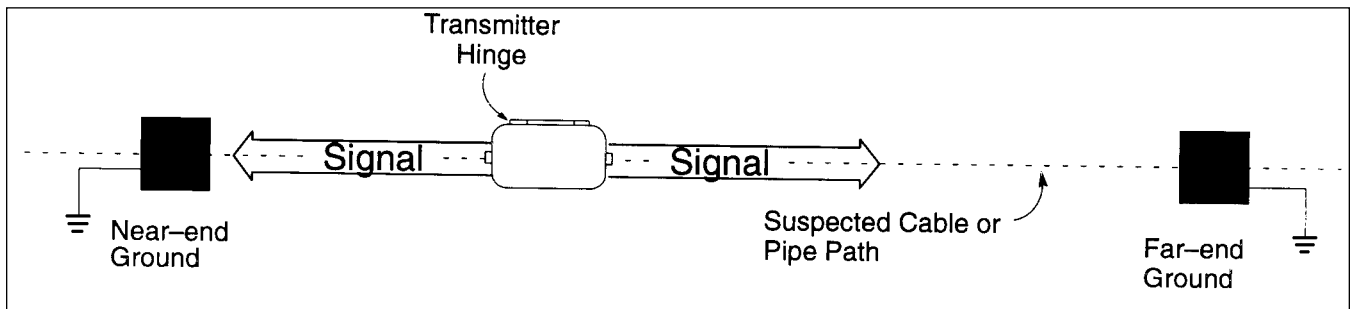

- 3.1 The Induction method broadcasts signal into an area. No access to the cable is necessary. Use this only when there are no other buried conductors present, or when locating all conductive buried services in a general area. Perform the following procedures to use the Induction method.
- 3.2 Place the Transmitter on the ground over the cable to be located. The Transmitter hinge should be in line with the cable path, as shown above. Be certain that the Transmitter is directly over the cable to be located.
- 3.3 Turn the Transmitter on and choose a frequency of 33 kHz or higher.
- 3.4 Use the Receiver to test the signal level by placing the Receiver 50 feet away from the Transmitter on the ground near the cable. Move the Transmitter back and forth across the path. Listen for strongest signal from the Receiver. If the Receiver has trouble picking up the cable path, return to the Transmitter and switch to a higher frequency. Recheck the signal level using the Receiver. If the highest Transmitter frequency will not give satisfactory Receiver response, then boost the Transmitter output as instructed in the unit's Operating Instructions.

4. Applying Signal to Power Cables: Dyna-Coupler Method

Warning: A potential for electrical shock exists when using the Dyna-Coupler on energized cables. Use appropriate safety procedures. **DO NOT USE ON CABLES CARRYING IN EXCESS OF 600 VOLTS RMS.**

A. Applying Signal to Primary Cables

4.1 Use the Dyna-Coupler method to put tracing signal on the neutral of either primary or secondary cables and energized cables. The neutral and its grounds form a circuit path for the signal to follow. When you apply signal with the Dyna-Coupler to the neutral anywhere between grounds, signal will be on the section between the grounds.

4.2 Where you clamp the Dyna-Coupler on the concentric neutral is very important. On three-phase primary cable, clamp the Dyna-Coupler on all the concentric neutrals as close to the earth ground as possible. The signal is coupled onto each cable equally.

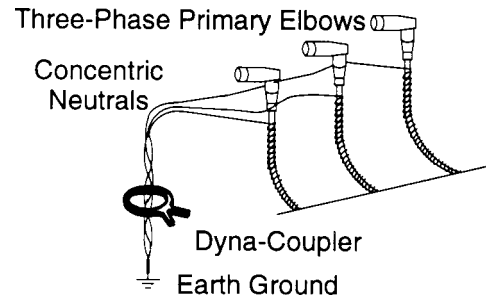

4.3 It is important not to place the Dyna-Coupler around one of the individual primary cables. Since the cables are buried in the same trench, this causes a canceling effect as signal goes one way on one cable and the opposite way on the other.

4.4 On single-phase primary cable used in a loop configuration, canceling is not a problem. You can apply signal with the Dyna-Coupler to the individual concentric neutral of the cable to be located as shown.

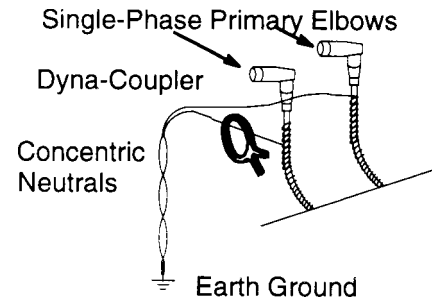

Note: Always use high output level with the coupler.

B. Applying Signal to Secondary Cables

- 4.5 To locate secondary cables, the easiest access to the neutral is at the meter box. There are several ways to put signal on the neutral. If the riser pipe is nonmetallic (usually PVC), clamp the Dyna-Coupler around the pipe as shown. The jaws of the coupler must fully close for signal transmission. This may be impossible if the riser is flush with the mounting structure.

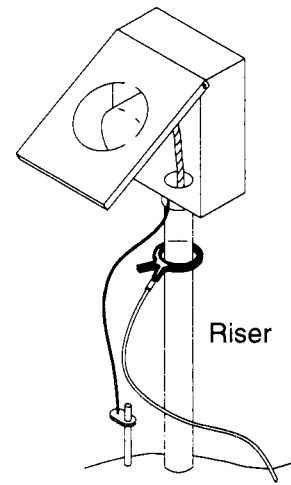

- 4.6 If the riser is flush with the mounting structure, it may be impossible to clamp the Dyna-Coupler around the riser. If this is the case and access is permitted, break the seal and open the meter box and clamp the Dyna-Coupler around the neutral in the box as shown.

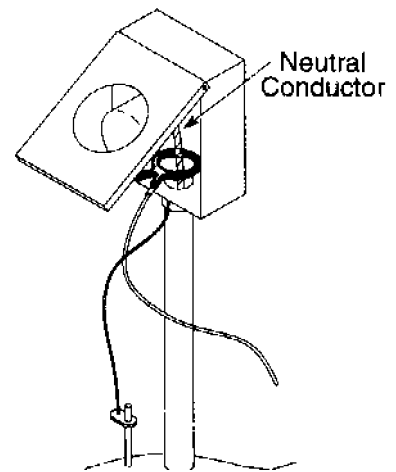

- 4.7 Some meters may have an external ground wire from the meter box to the ground rod. Clamp the Dyna-Coupler around the wire as shown. This puts signal on the neutral since the ground wire is connected to the neutral in the meter box. Make sure you place the Dyna-Coupler above other utilities grounded at the ground rod, or signal may be coupled to them also.

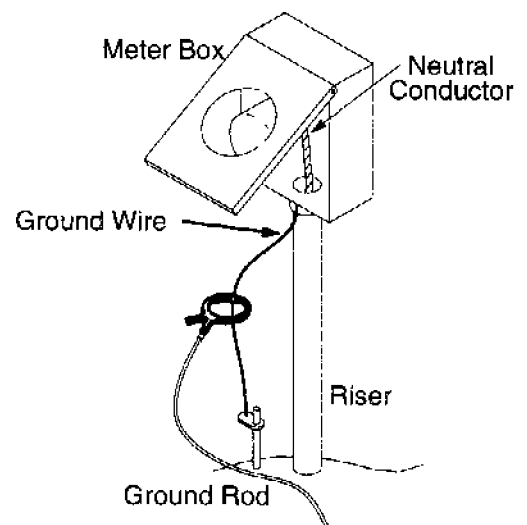

5. Identifying Slack Loops

- 5.1 To identify the presence of a slack loop in the cable path, first locate and mark the cable path. Then find the maximum response over the marked cable path and press the gain adjust key.
- 5.2 Retrace the cable path with the Receiver held so the handle is perpendicular to (across) the cable path, as shown. When the Receiver passes over a slack loop, the signal increases and the bar graph closes. Mark each response.

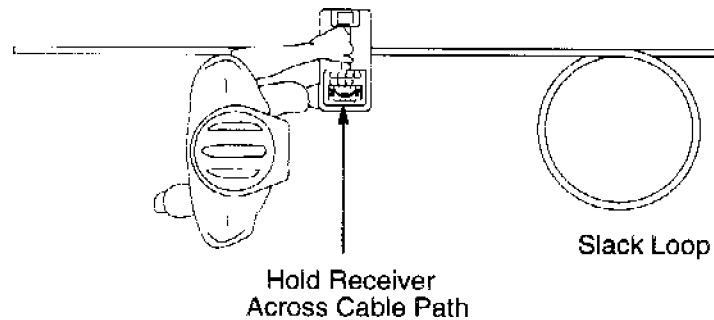

6. Identifying A Cable Open End

- 6.1 It is sometimes necessary to locate the open end of a buried cable. The cable could have been severed or buried intentionally as in new construction. If the cable end is insulated from earth ground, use the following technique.
- 6.2 Connect the Transmitter using the Direct Connect method. Use the continuity function to see if the buried end is in contact with earth ground (low resistance). If the resistance is high, choose the highest frequency available.
- 6.3 Set the Receiver to match the Transmitter frequency and trace the cable path. The signal decreases suddenly at the site of the ungrounded end.

7. Identifying Primary Power Cables

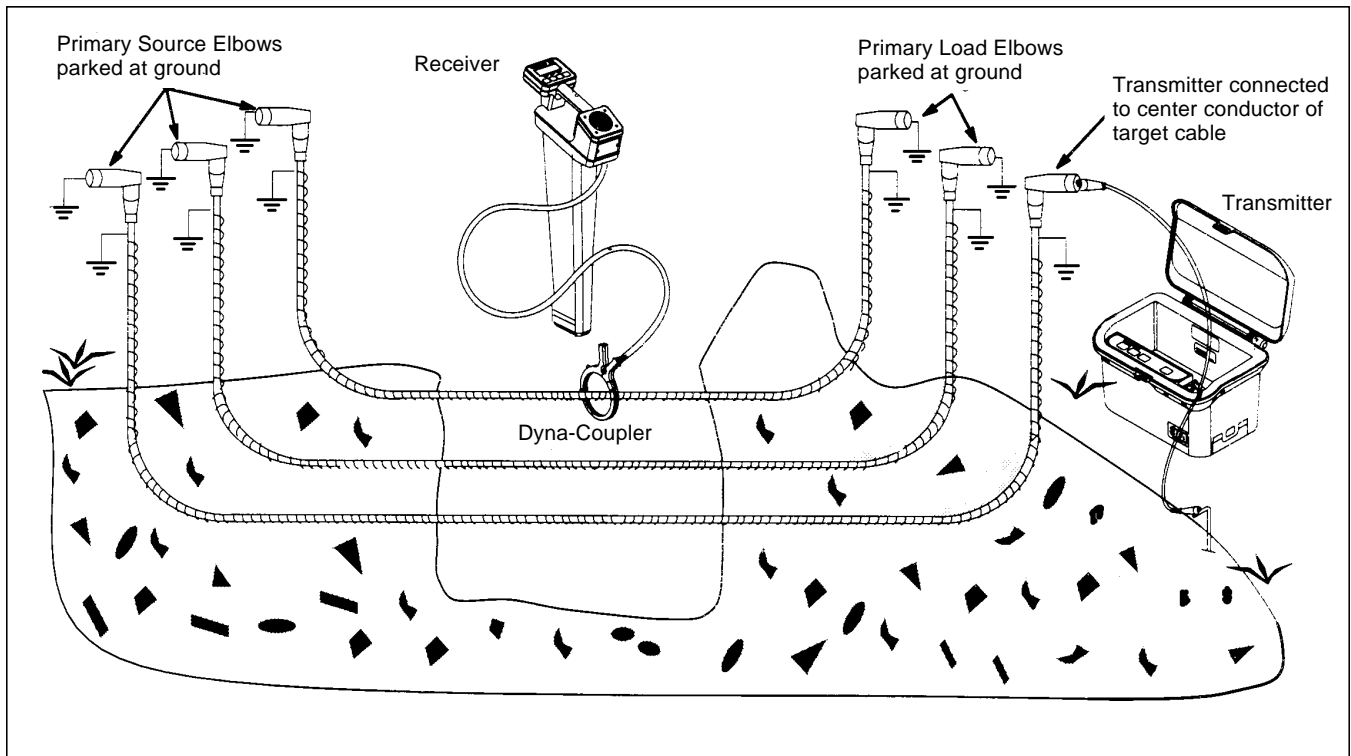

- 7.1 This procedure uses the Receiver and a Dyna-Coupler to identify a particular primary cable in a group of similar cables. This operation is sometimes called phasing. The Transmitter is used to apply tone to the target cable using the direct-connect method.
- 7.2 Follow standard procedures and remove the source elbows and park them at ground. Remove the load elbows and park at ground. After all phases have been de-energized and discharged, at the load end, remove the cable to be identified from ground.
- 7.3 Apply Transmitter signal using the direct-connect method to the center conductor of the primary cable carrying the phase to be identified. Use the lowest trace frequency available.
- 7.4 At the access where the cable is to be identified, connect a Dyna-Coupler to the Receiver with the Extension Cable. Select the PEAK selection of trace mode and select the same frequency as the Transmitter.
- 7.5 Check the first cable in the group by clamping the Dyna-Coupler around the cable. Press the GAIN ADJUST key and observe the numeric display for relative signal strength. Remember the number and continue by clamping the Dyna-Coupler around the next cable in the group. If the signal strength is greater than the previous observation, press the GAIN ADJUST key. If the signal strength is less than before, ignore it. After checking all the cables in the group, the cable with the highest reading is the target cable. Without pressing the GAIN ADJUST key, verify by re-clamping the Dyna-Coupler around each cable. Only the target cable should have tone on it.

8. Locating Open Concentric Neutrals

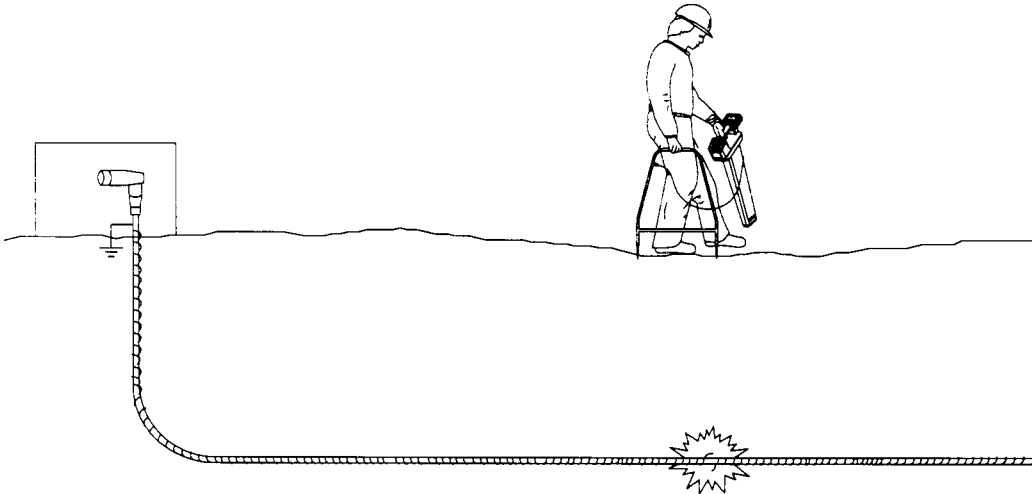

- 8.1 Open primary concentric neutral conductors will cause the normal neutral current to seek a path around the open. This path is usually through the adjacent earth and will cause a voltage gradient around the open. The 60 Hz voltage can be detected at the surface using the earth contact frame. If you are confident that an open concentric neutral exists, follow the procedure below to locate the open.

IMPORTANT

Neutral current may find a path around the open which is not through the earth. A bare CATV splice or other utility services which are common-bonded (grounded at the same point as the power utility) may be carrying the neutral current. In which case, this method may not work.

- a. Carefully trace and mark the path of the cable so that it can be followed easily.
- b. After tracing the path, connect the Earth Contact Frame to the Receiver. Turn the Receiver on and select the tone mode. Next, press the frequency key to select the power frequency selection (50/60 Hz).
- c. Hold the Receiver in one hand and the Earth Contact Frame in the other. Starting at least 20 feet away from the transformer, insert the frame probes fully into the ground parallel and as close as possible to the marked cable path. Press the gain adjust key.
- d. Continue along the marked cable path, reinserting the frame probes every few steps while watching the receiver bar graph. You may also listen to the speaker audio. Remember to keep the frame parallel to the cable path.
- e. When the bar graph and speaker indicate an increase in signal strength, proceed slowly, inserting the frame probes every few inches. Locate a point on the marked path where the bar graph indicates maximum closure. If the bar graph completely closes, press the gain adjust. The maximum indication may be rather sharp. In other words, frame movements on the order of 5 or 6 feet may go from one side of the maximum to the other. The open neutral will be located beneath the center of the frame at maximum closure.

9. Locating Buried Streetlight Cables

- 9.1 Buried cables that bring power to streetlights are normally not energized in the daytime. Each streetlight has a light sensitive switch that will open during daylight hours. Trying to locate these cables using the passive power frequencies (either 50 or 60 Hz) will not work.
- 9.2 Street light cables appear to be floating (no grounds) since the supply is a transformer and the light sensitive switch is open. This means there is no return path for a tracing signal to return to the transmitter. To put a tracing signal on the cable, use the Dyna-Coupler and the highest frequency available (200 kHz). The easiest point to apply the signal is at the base of the light. Before you dig, check all the nearby streetlights to keep from excavating a dangerous power cable.

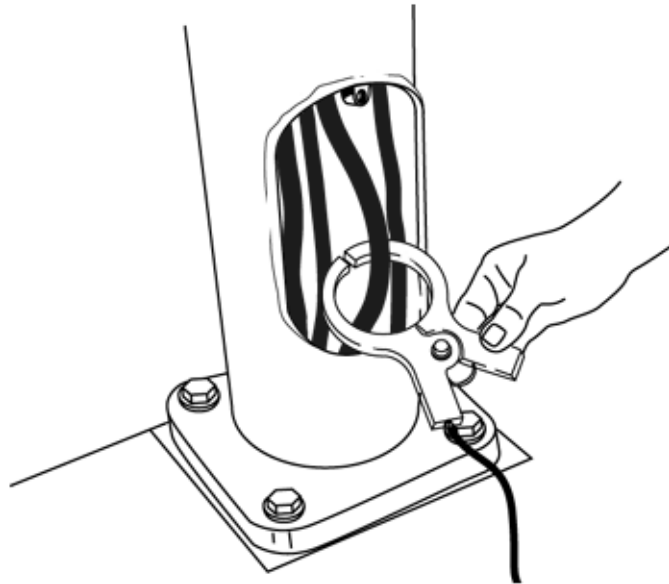

Section 4 CATV Cable Locating Techniques

1. Introduction

- 1.1 Read Section One of this manual to learn more general information about each of the following tone application methods. The following paragraphs provide specific instruction on applying tone for CATV (cable television) cable locating.

2. Applying Signal to CATV Cables: Induction Method

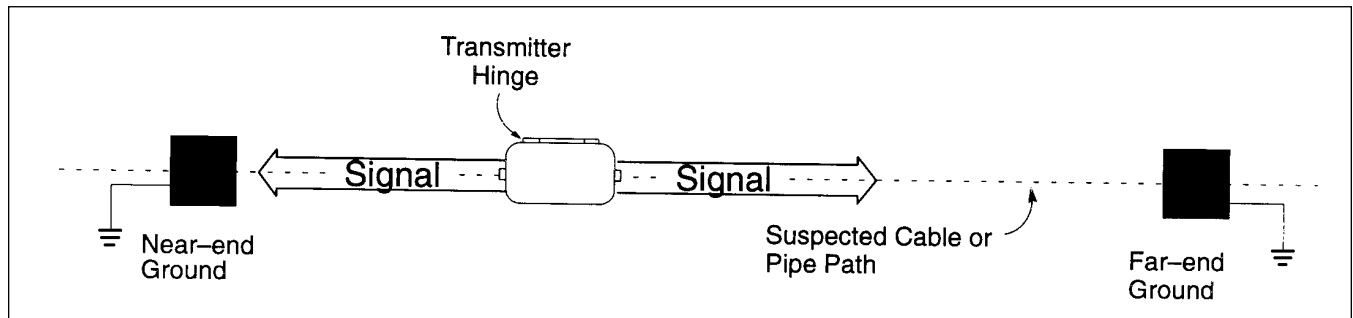

- 2.1 The Induction method broadcasts signal into an area. No access to the cable is necessary. Use this only when there are no other buried conductors present, or when locating all conductive buried services in a general area. Perform the following steps to use the Induction method.
- 2.2 Place the Transmitter on the ground over the cable to be located. The Transmitter hinge should be in line with the cable path, as shown above. Be certain that the Transmitter is directly over the cable to be located.
- 2.3 Turn the Transmitter on and choose a frequency of 33 kHz or higher.
- 2.4 Use the Receiver to test the signal level by placing the Receiver 50 feet away from the Transmitter on the ground near the cable. Move the Transmitter back and forth across the path. Listen for the strongest signal from the Receiver. If the Receiver has trouble picking up the cable path, return to the Transmitter and switch to a higher frequency. If the highest Transmitter frequency will not give satisfactory Receiver response, then boost the Transmitter output as instructed in the unit's Operating Instructions.

3. Applying Signal to CATV Cables: Direct-Connect Method

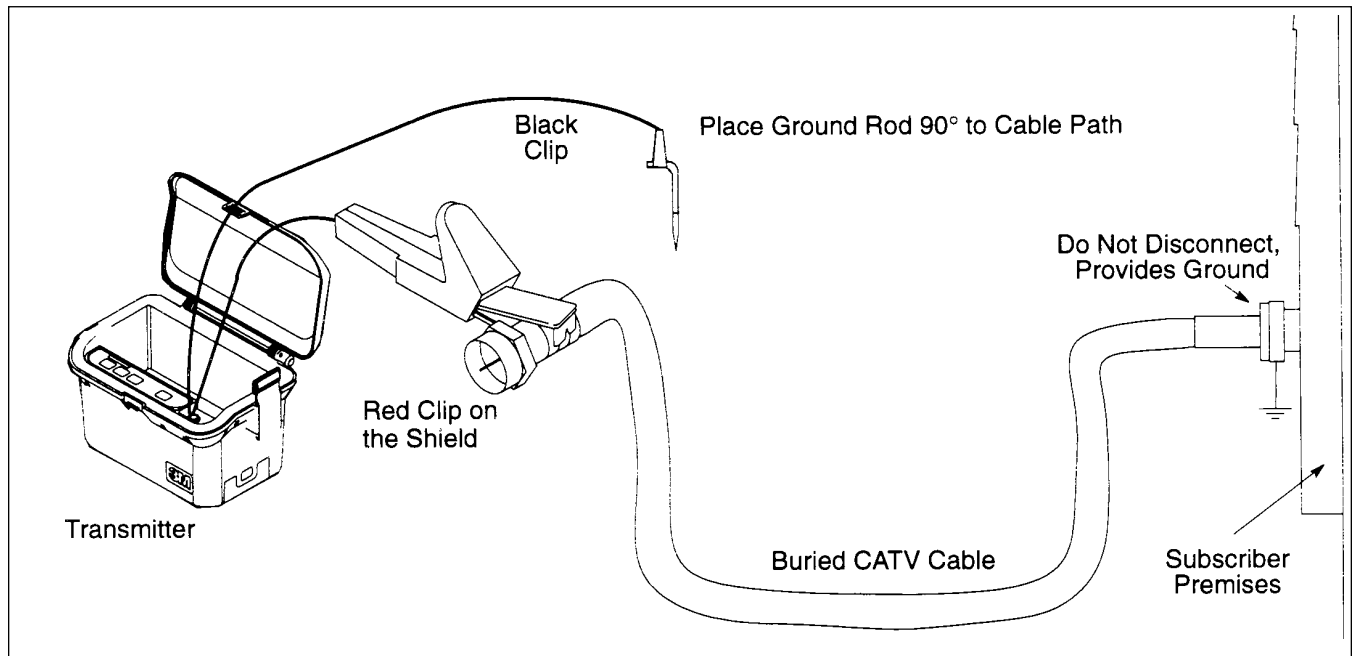

- 3.1 The direct-connect method requires access to the cable shield. Disconnect the cable at the near-end where the Transmitter is connected. Do not disconnect at the far-end (subscriber's premises) since this supplies a far-end ground. Perform the following steps to use the direct-connect method.
- 3.2 Connect the red lead of the Transmitter to the cable shield and the black lead to the ground rod.
- 3.3 Place the ground rod as far away from the cable path as possible (90 degrees from the suspected cable path). Never ground to water pipe or other services in the area. The returning signal on these services may mislead the trace.
- 3.4 Remove the ground bonding at the near-end. The far-end should have a good ground. Turn the Transmitter on and choose a low frequency signal to get greater signal distance down the cable.

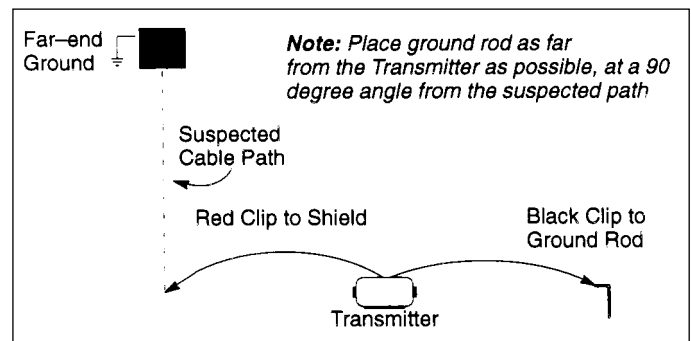

4. Applying Signal to CATV Cables: Dyna-Coupler Method

4.1 The Dyna-Coupler is the easiest method to apply signal to a CATV cable. It is not necessary to disconnect the cable. Open the Dyna-Coupler jaws and place them around the desired cable. Make sure that the jaws close completely. The Dyna-Coupler couples the Transmitter signal onto the cable. The cable and its shield grounds form a complete circuit path for the signal to follow. When the Dyna-Coupler is applied to the cable anywhere between earth grounds, signal is on the section between the grounds. Be aware that the shield may be grounded at the subscriber's premises and also at a bridging amplifier on an aerial feeder line several blocks away. Everything between these grounds will carry signal. A removable ground (use the ground rod and ground extension cable) placed at a surface access point limits signal to that part of the cable between the grounds and keeps signal from going where it is not needed. Remove the ground when the job is finished.

Note: Always use high output level with the coupler.

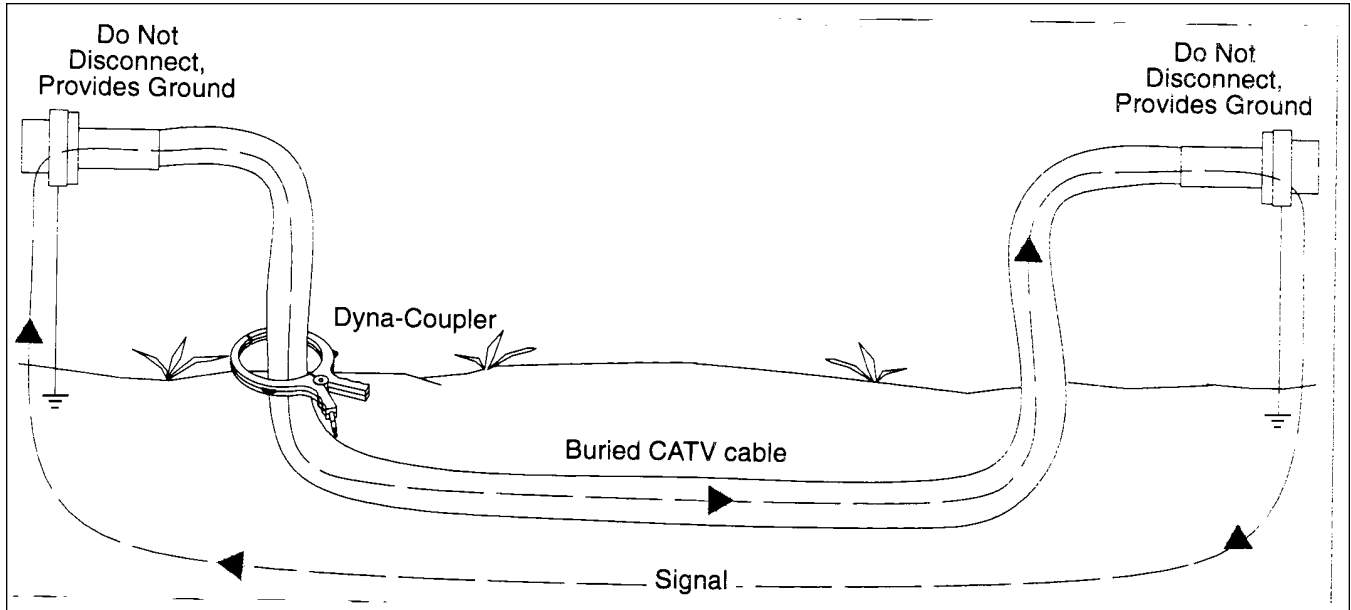

4.2 The Dyna-Coupler can identify one of several CATV cables which fan out from a common point, as in a header pedestal. Even though signal is coupled onto each cable, the cable with the Dyna-Coupler is clearly identifiable because it has the strongest signal. If the header is not grounded in the pedestal, do so using the ground rod and the ground extension cable. This helps shorten the ground return path and increases signal.

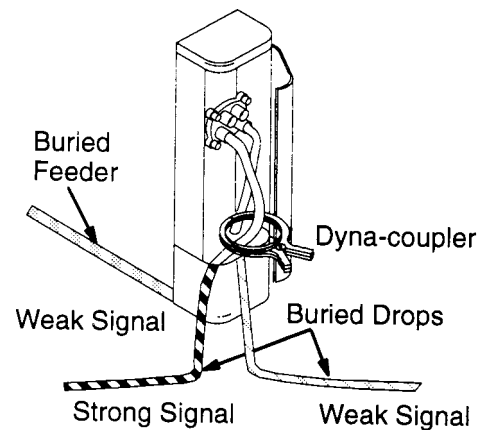

5. Locating Cable Slack Loops

- 5.1 To identify the presence of a slack loop in the cable path, first locate and mark the cable path. Retrace the path in the following manner:

Find the strongest response over the marked cable path and press the gain adjust key.

Hold the Receiver so the handle is perpendicular to (across) the cable path, and retrace the cable path. When the Receiver passes over a slack loop, the tone increases and the bar graph closes. Mark each response.

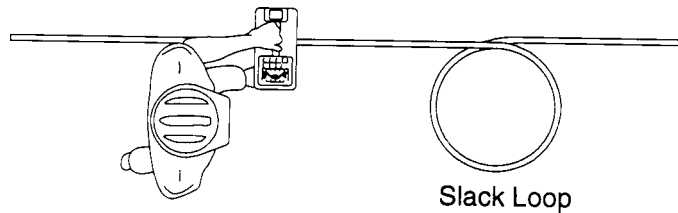

6. Locating Cables from Pedestals

- 6.1 To locate a single CATV cable path from a pedestal, follow these steps:
- 6.2 At the pedestal, apply tracing tone on the target cable using the Dyna-Coupler method. If the header in the pedestal is not grounded, use the ground rod and ground extension cable to ground it.
- 6.3 Walk 10 to 25 feet away from the pedestal holding the Receiver so that the display end of the handle points directly away from the pedestal. Start walking in a circle around the pedestal with the Receiver always pointing outward.
- 6.4 The Receiver remains relatively quiet until it crosses a cable. Stop when there is a response. Find the point of strongest response and press the gain adjust key. Check the numeric display for relative signal strength. Remember the number and continue walking the circle. As you walk away from the cable, the signal drops. Press the gain adjust key and continue. When another response is encountered, find the point of strongest signal response. If the greatest signal strength is more than 25 points higher than the others (if any found), then that is the target cable. If the signal levels are closer, then measure the depth of each cable found and note the bar graph in the depth mode (this is a relative measurement of the current flowing in the cable). The cable that shows at least two more segments on the bar graph than the other cables is the target cable.

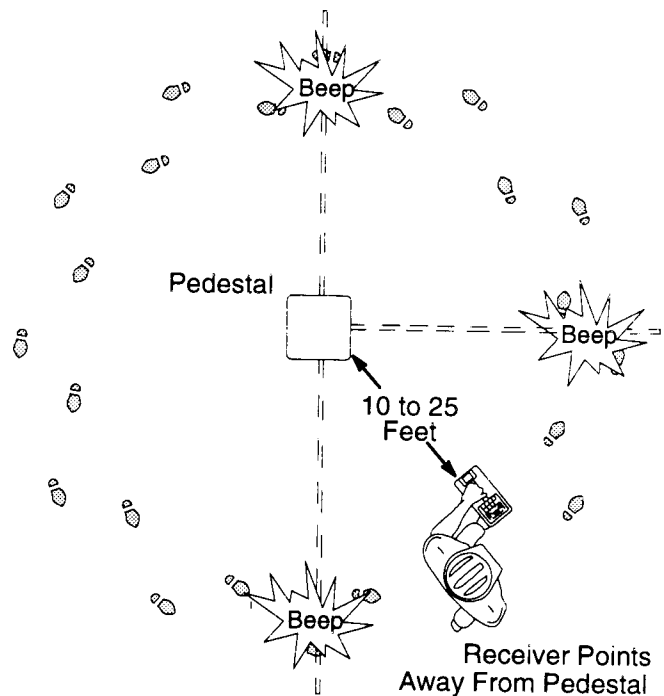

Section 5 Pipe Locating Techniques

1. Introduction

- 1.1 Read Section One of this manual to learn more general information about each of the following signal application methods. The following paragraphs provide specific instruction on applying signals for pipe locating.

2. Applying Signal to Pipe: Induction Method

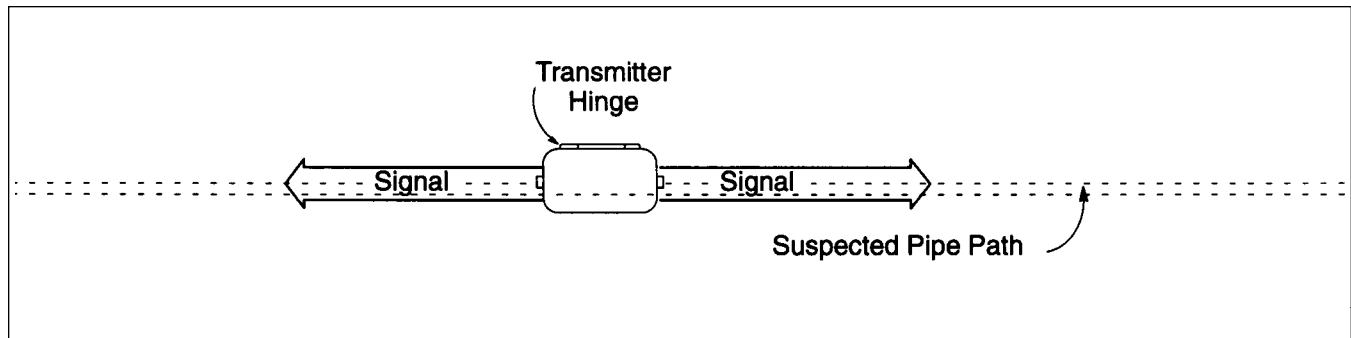

- 2.1 The Induction method broadcasts signal into an area. No access to the cable is necessary. Use this only when there are no other buried conductors present, or when locating all conductive buried services in a general area. Perform the following steps to use the Induction method.
- 2.2 Place the Transmitter on the ground over the cable to be located. The Transmitter hinge should be in line with the cable path, as shown above. Be certain that the Transmitter is directly over the cable to be located.
- 2.3 Turn the Transmitter on and choose 33 kHz signal or higher.
- 2.4 Use the Receiver to test the signal level by placing the Receiver 50 feet away from the Transmitter on the ground near the cable. Move the Transmitter back and forth across the path. Listen for strongest signal from the Receiver. If the Receiver has trouble picking up the cable path, return to the Transmitter and switch to a higher frequency. If the highest Transmitter frequency will not give satisfactory Receiver response, then boost the Transmitter output as instructed in the unit's Operators Instructions. You can also increase the response by placing the Transmitter on the located position over the cable (50 feet away from the Transmitter's previous position).

3. Applying Signal to Pipe: Direct-Connect Method

- 3.1 You can use the Direct-connect method to apply tracing signal to a coated metallic pipe at an access point such as a valve, meter, or the metal pipe itself. The red lead is connected to the pipe and signal current travels down the pipe. The return path to the Transmitter is through a far-end earth ground such as a screwdriver stuck in the ground or by system grounding at buildings. The circuit is completed by connecting the black lead to the ground rod. Ground rod placement should be as far away from the trace path as possible and at a right angle to the path. With an arrangement like this, use a low Transmitter frequency. Sometimes a pipe system is sectionalized by using nonconducting gaskets at selected pipe joints. These insulated pipe joints stop the signal current. After application of the far-end ground, use the ohms mode on the Transmitter to check if the circuit is complete.

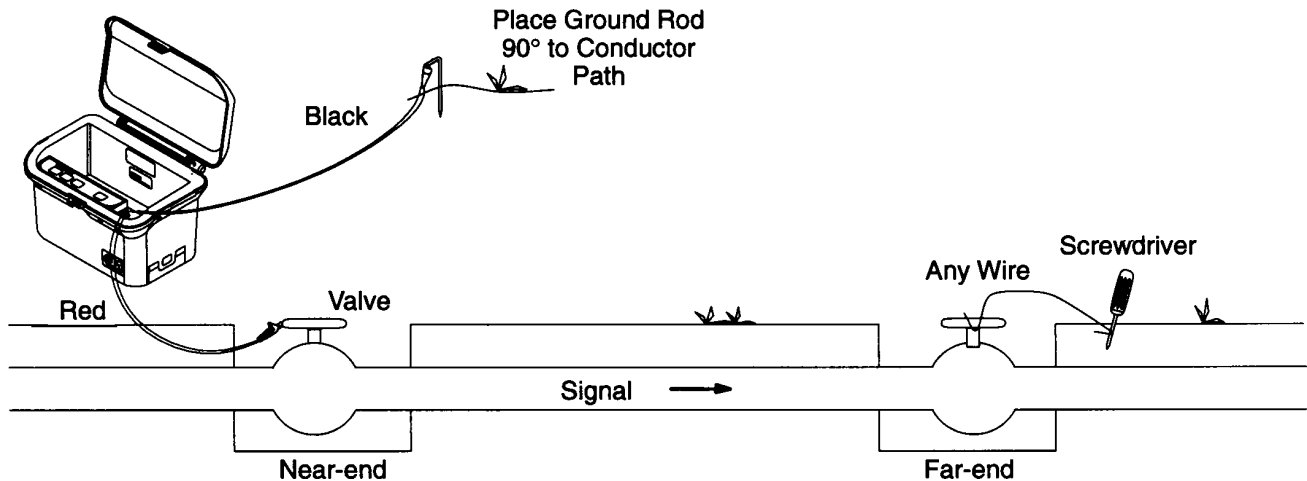

- 3.2 A far-end access point may not be available to apply a far-end ground. If this is the case, you can still use the direct-connect method. The red lead connected to the pipe sends signal current in both directions from the application point. The signal continuously 'leaks off' the pipe and returns to the Transmitter ground rod connected to the black lead. The rate at which the current leaks away from the pipe determines how far down the pipe the signal can be detected. Two factors that control this distance are the pipe size (diameter) and the frequency of the Transmitter. A general rule of thumb to maximize the detection distance is 'big pipe - low frequency' or 'small pipe - high frequency.' Select the lowest frequency which provides adequate signal for the receiver. Setting the transmitter output level to high output increases the detection distance but only if the frequency is correct. Ground rod placement should be as far away from the trace path as possible and at a right angle to the path.

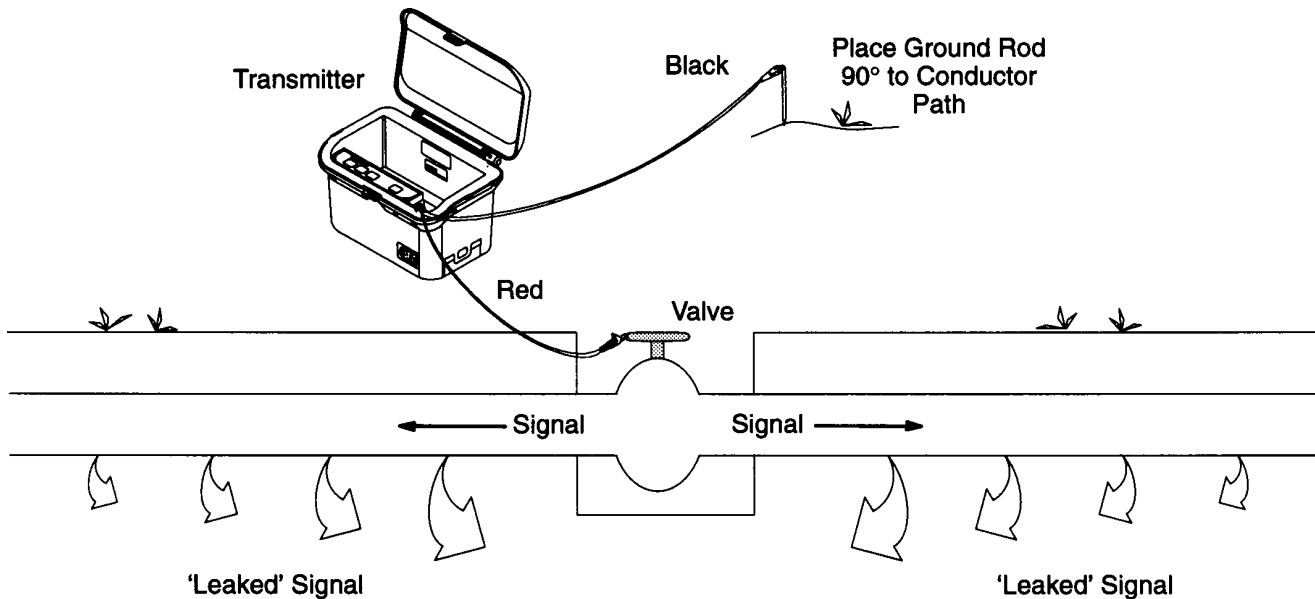

A. Direct-Connect Method on Tracer Wires

- 3.3 To locate tracer wires buried with nonmetallic pipe, connect the Transmitter's red lead to the tracer wire at an access point. The black lead is connected to the ground rod. For best results, ground the tracer wire at the far-end. If you cannot access or locate the far-end, use a high Transmitter frequency. Otherwise, use a low Transmitter frequency. If you use a high frequency, be aware that in some installations a tracer wire for a service line may not be electrically connected to the tracer wire for the mainline. The purpose is to reduce confusion by not allowing tracing signal applied to the main from appearing on the service line. The unconnected end of the service tracer wire may have been placed in the trench and covered or it may have been twisted around the tracer wire for the main. If the twist method was used and the Transmitter frequency is high, signal may appear on both the main and service tracer wires. High frequency signal couples from one tracer wire to the other through the twist, even though there is no metallic connection.

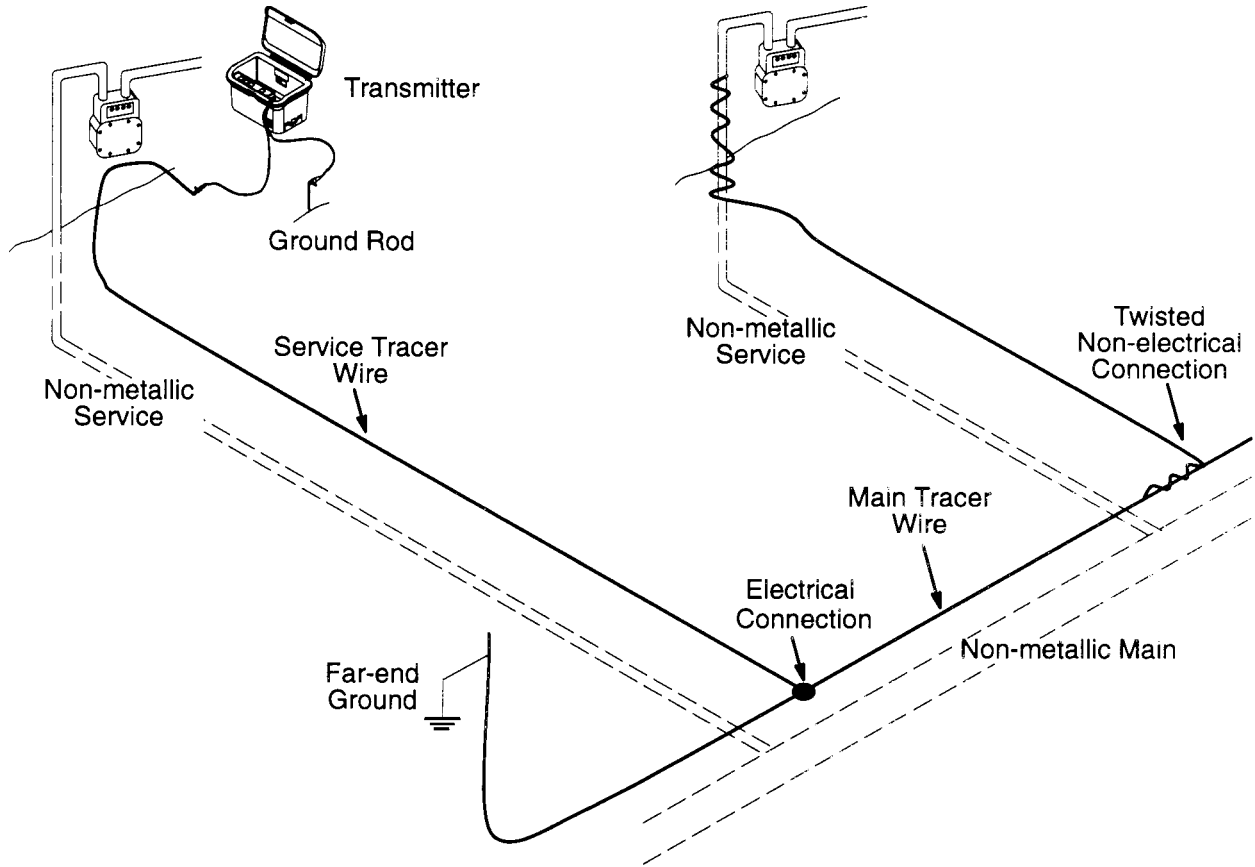

4. Apply Signal to Pipe: Dyna-Coupler Method

- 4.1 The Dyna-Coupler method works well on buried metallic pipe. When the Dyna-Coupler is clamped around a pipe, you can detect signal on either side.

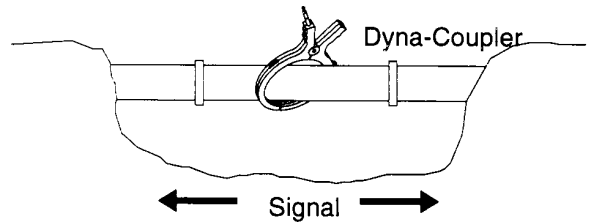

- 4.2 You can control the direction of the signal on the pipe by using the ground rod and ground extension cable to apply ground to that part of the pipe where signal is not needed, as shown. The external ground keeps the signal off the pipe on that side of the Dyna-Coupler. Since the signal is being sent to only one part of the pipe, the signal magnitude is greater on that part.

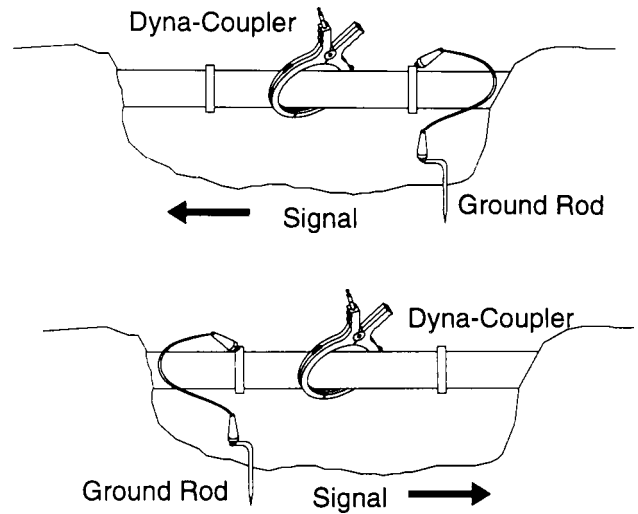

- 4.3 When you use the Dyna-Coupler to apply signal to a metallic service line at a gas meter, always ground the valve. This provides good return for signal. Otherwise, the insulating coupling above the valve isolates the returning signal from ground and may make locating the service line difficult.

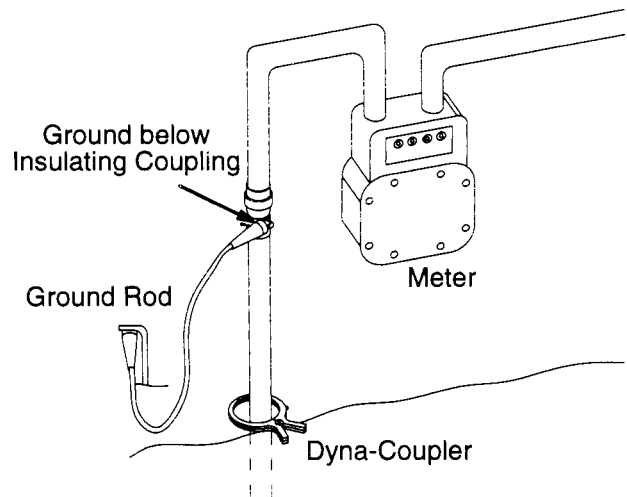

5. Locating Non metallic Pipe

- 5.1 One end of the pipe must be accessible. Push a metal fish tape, snake, or heavy gauge wire into the pipe. Use a direct-connect hookup to the tape, snake or wire and choose 33 kHz signal or higher to locate.

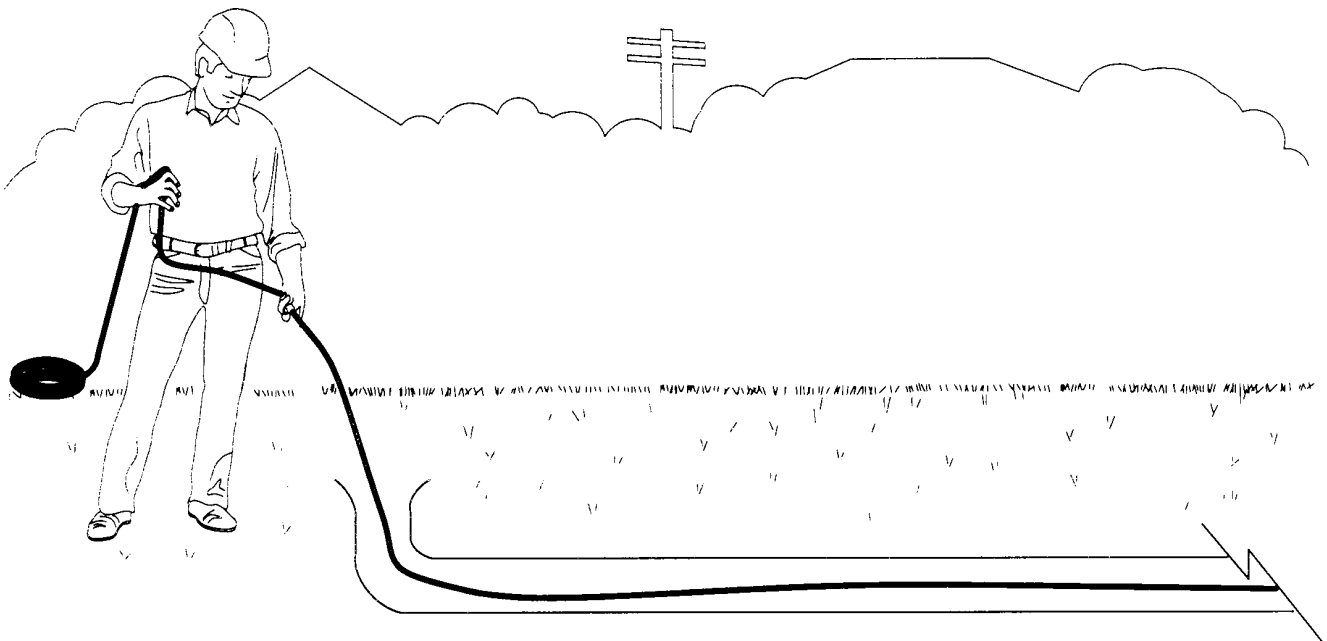

6. Locating Pipe with Impressed Cathodic Protection

- 6.1 An impressed current cathodic protection system uses an AC powered rectifier as a source of DC current. The current flows from buried anodes to the pipeline to protect it from corrosion.
- 6.2 To trace the path of the pipe, use the second harmonic of the 50 or 60 Hz passive power frequency (100 or 120 Hz) in Peak mode. This frequency is especially sensitive to rectified AC signals.
- 6.3 You can also locate the anodes and find a broken anode lead using this frequency. As you trace the path of the anode lead past a buried anode, the signal strength will drop (numeric indicator decreases). At a broken lead wire, the signal diminishes suddenly to nothing.

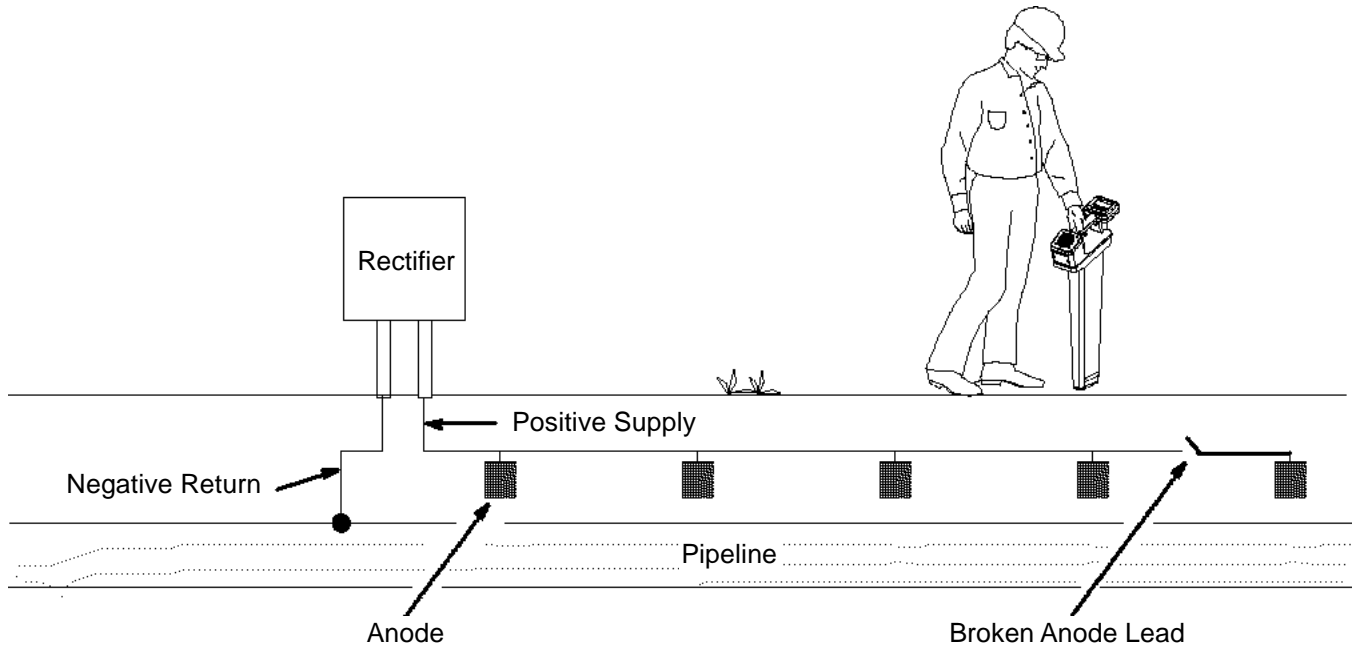

Section 6 Locating Faults

1. Introduction

- 1.1 Sheathed cables with a metallic shield (CATV and some telephone cables) can experience damage to the sheath which exposes the shield to contact with the earth. These damaged spots on cables are called sheath faults because the damaged sheath allows water to enter the cable creating a fault which may degrade service. Buried power distribution cables have no shield but damage to the insulation can expose the conductor to earth creating a fault condition.

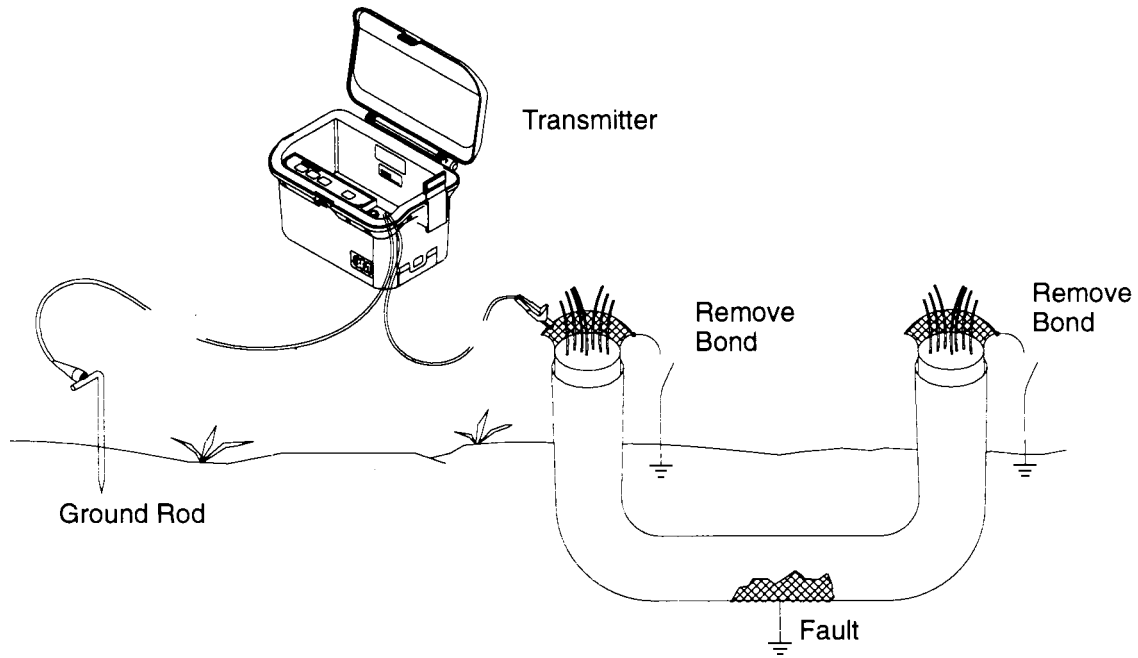

Transmitter Connection for Faults

2. Locating Sheath Faults

- 2.1 To locate a sheath earth return fault, the Transmitter sends a current down the shield to the damaged sheath (the fault) and back to the ground rod through the earth. The operator uses the earth contact frame to find the point where the current stops traveling through the shield and starts traveling through the earth. At the same time, tracing tone may be applied to the faulted section to help find the buried cable. This is especially useful if the cable passes under concrete or asphalt. Perform the following steps to locate a sheath fault:

Make sure both the near-end and far-end shield bonds (shield grounds) are removed from the test section.

Attach the Transmitter to the cable as shown above. Select the fault mode.

Always measure the resistance between shield and ground to verify the fault exists. Use the Transmitter ohms mode. To determine if a sheath fault exists, use the following criterion:

Resistance greater than 1.0 megohms: no significant fault exists in the cable sheath.

Resistance between 1.0 megohms and 50,000 ohms: a high resistance fault exists that may or may not cause problems yet but gets worse with time.

Resistance less than 50,000 ohms: a heavy fault exists between the shield and ground. Failure to disconnect the shield bonds at either the near-end or the far-end produces a heavy fault reading.

Connect the Earth Contact Frame to the Receiver using the frame cable.

Turn the Receiver on and place the Receiver in fault mode.

Hold the Receiver in one hand and the earth contact frame in the other with the green-banded leg toward the fault. Near the location of the ground rod, insert the frame probes fully into the ground in line with the cable path while facing the section under test. The Receiver bar graph is visible on the right side (green). This indicates that the fault is ahead of the operator in the direction of the green-banded leg.

Continue along the cable path, reinserting the frame probes every few steps while watching the Receiver bar graph.

Note: A high resistance of distant earth fault may cause the bar graph to become very small or even invisible. However, it increases as the operator gets closer to the fault. This is because the signal is highest at the ground rod and at the fault, but drops off between. If the bar graph shows random changes in magnitude or erratic reversals over the entire test section, no fault is on the section.

When the bar graph is visible on the left side (red), the fault has been passed and is now behind the operator.

Move back, inserting the frame every few inches, until the bar graph returns to the green side. The fault is located beneath the center of the frame when the bar graph changes from one side to the other.

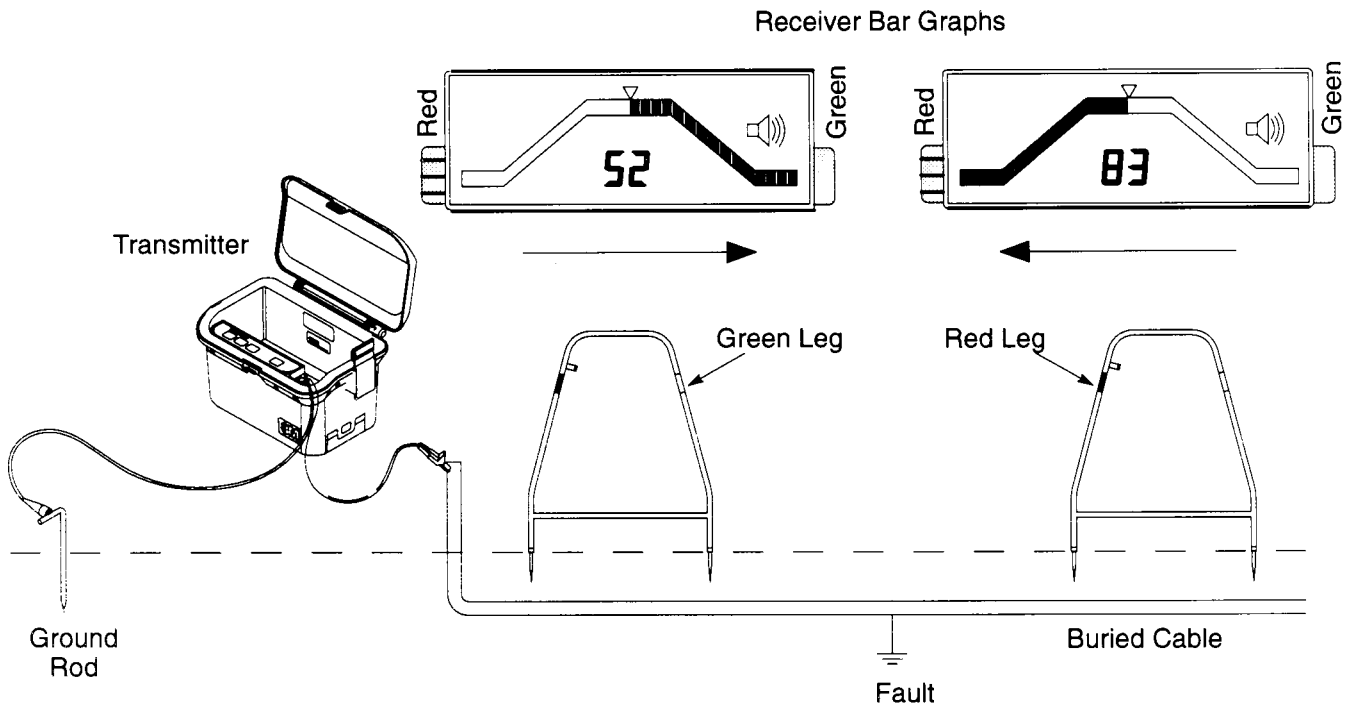

Receiver Bar Graph Indications Around a Fault

- 2.2 To verify the fault location, insert the frame's red probe directly on the spot between the legs. Pivot the frame in a circle around the red leg, reinserting the green leg in the ground every few degrees of the circle. The bar graph should always be on the left (red), indicating that the fault is directly below the red leg.

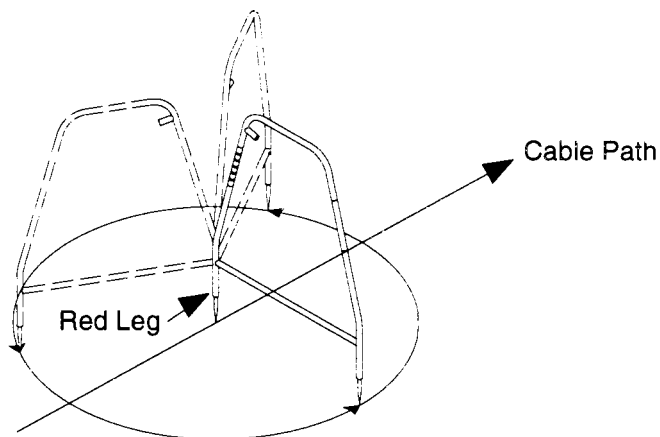

Pinpointing an Earth Fault

A. Locating Faults Near Pedestals

- 2.3 The placement of the ground rod can have unfavorable effects on locating a fault that is very close to a pedestal. The pedestal is the access point for applying the Transmitter signal. If the fault is very close (a few feet, at most), and the ground rod is also very close, it may be impossible to find the fault. The returning currents from the fault are so distorted by close ground rod placement that the earth contact frame cannot recognize the fault. A good practice is to use the ground extension cable and always place the ground rod as far away from the pedestal as possible and in line with the suspected cable path.

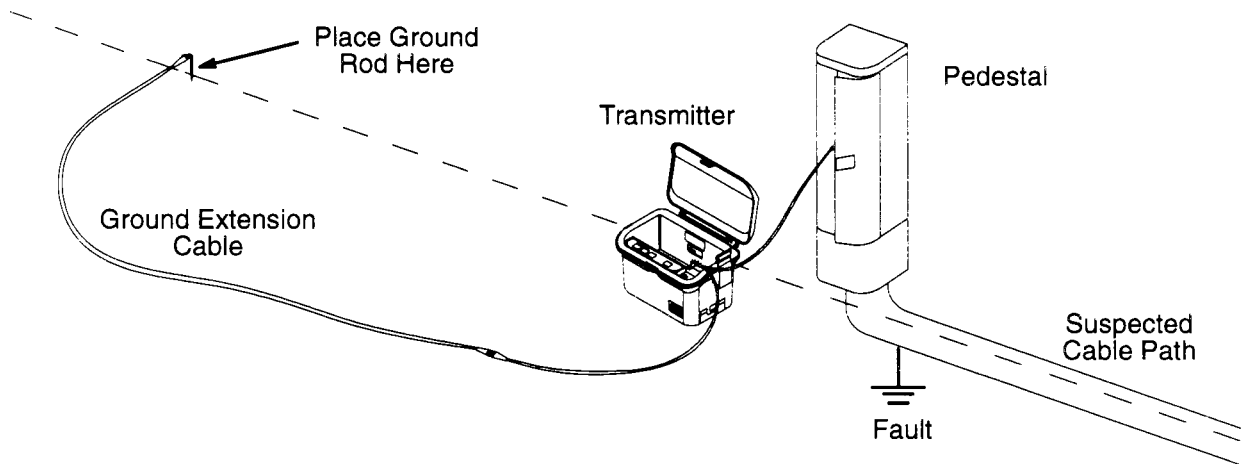

Ground Rod Placement

B. Locating Faults Under Pavement

- 2.4 When the cable is routed beneath and in line with a paved surface, you can locate the fault using one of the following methods.

Perpendicular Method

- 2.5 Hold the frame parallel to the cable path but several feet to the side of the cable path. Bar graph reversal occurs when the frame center is directly perpendicular to the fault.

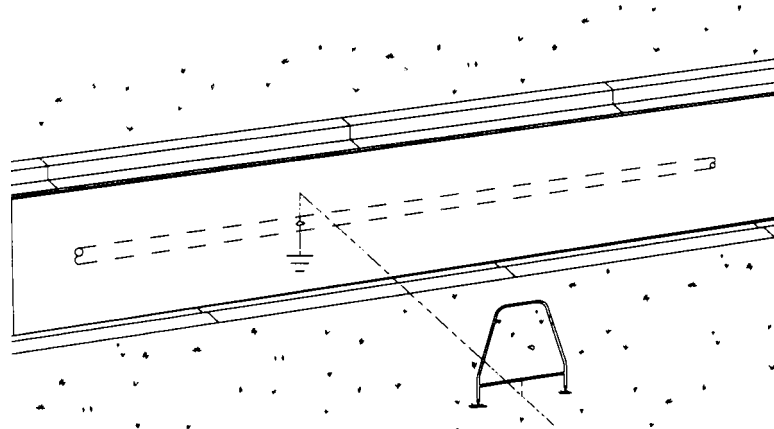

Perpendicular Method

Triangulation Method

- 2.6 To check the accuracy of the Perpendicular method, move back several yards from the point of bar graph reversal. Probe in one spot with the frame, rotating it a few degrees between inserts, until the bar graph reverses with less than one inch of frame movement. A line marked perpendicular to the frame intersects the cable path at the fault. Repeat this procedure a few yards ahead of the Perpendicular method location to triangulate and confirm the location.

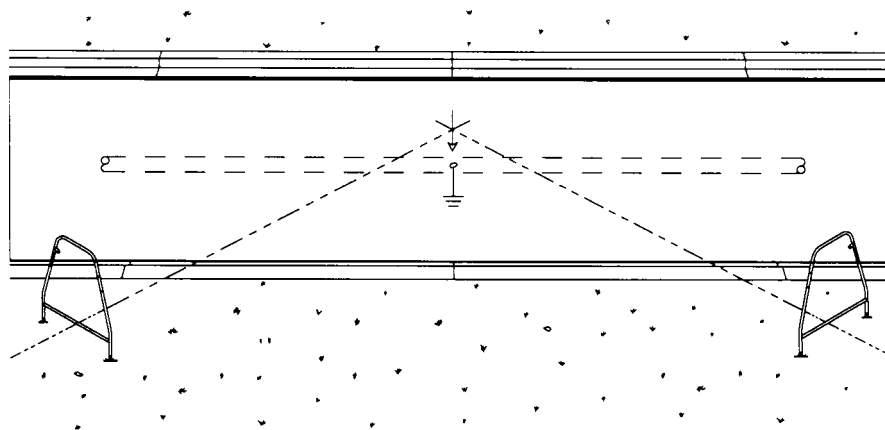

Triangulation Method

Extended Frame Methods

2.7 Where a cable passes under a roadbed or other narrow stretch of pavement, and a check on both sides with the frame proves the fault to be under the roadway, triangulating the fault from both sides of the road gives a general indication of the fault location. A more accurate method is to extend the distance between the probe tips:

Insert the green leg in earth on the far side of the fault, but do not insert the red leg. Strip about ten inches of an insulated conductor such as cross-connect wire and wrap it around the red probe. Pull out enough wire to equal twice the width of the road. Strip another ten inches of insulation from the far-end and wrap it around a screwdriver. Ground the screwdriver at a point in line with the cable path across the road from the Receiver. The screwdriver acts as an extension of the frame's red probe.

Return to the Receiver, making sure the red probe of the frame is held clear of the ground, and note the bar graph. If the bar graph is indicating the striped (red) side, the fault is nearest the grounded wire side of the road. If working alone, it helps to reverse the positions of the frame and the screwdriver at this reading.

If the bar graph is indicating the green (solid) side, move the frame forward along the cable path, probing with the green leg and keeping the red probe clear, until the bar graph reverses.

Once the reversal point is established, pull the wire tight between the two contact points. The fault lies exactly half the distance between the green probe and the screwdriver as measured by the tight wire. Fold the wire in half above the cable path for an exact fault location from either contact point.

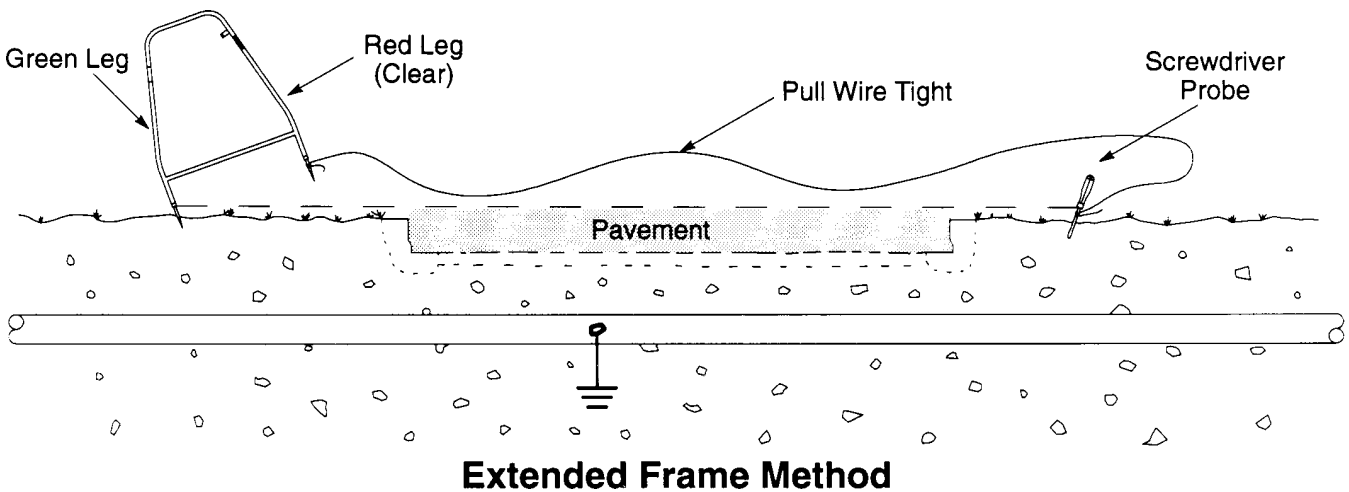

C. Finding a Fault without Tracing the Cable Path

2.8 Since the green leg of the Earth contact Frame points to the fault, tracing the path before or during the fault finding process may not be necessary. This technique uses 90 degree turns to pinpoint the fault. It usually requires at least three such turns and is called the 'three-ninety' method:

Start in the normal manner by holding the Receiver in one hand and the Earth Contact Frame in the other with the green-banded leg towards the fault. Near the location of the ground rod, insert the frame probes fully into the ground.

The Receiver bar graph is visible on the right (green) side. This indicates that the fault is ahead of the operator in the direction of the green-banded leg of the earth contact frame.

Since the green leg of the frame points toward the fault, continue in that direction reinserting the frame probes every few steps while watching the Receiver bar graph.

When the bar graph reverses and becomes visible on the left (striped or red) side, turn the earth contact frame 90 degrees either right or left until the bar graph is again visible on the right (green) side. Continue in that direction reinserting the frame probes every few steps until another reversal occurs.

Every time the bar graph reverses, turn 90 degrees and continue in the green direction. By the third reversal the fault is very close, so make frame insertions every few inches.

At the fourth reversal, back up slowly, inserting the frame every few inches until the bar graph returns to the green side. The fault is located beneath the center of the frame when the bar changes from green side to the red side.

D. Multiple Faults

- 2.9 The problem with multiple faults on a cable is finding the major fault. Digging a hole to fix a pinhole in the sheath when a fault that disrupts service is farther down the cable can be frustrating. The procedure below will prevent this from happening:

When setting up the transmitter to find faults be sure to set the output level to high so that the fault sensitivity will be highest. You want to find all the faults on the cable. Do not change the output level setting during fault locating.

Near the location of the ground rod (about one frame width away), insert the frame probes fully into the ground with the green banded leg toward the fault. Record the fault level reference by pressing Gain/REF key. This reading is a gauge of the signal returning to the ground rod from all the faults on the cable.

When a fault is found and pinpointed, move the Earth Contact Frame about one frame width away from the fault and insert it in the ground with the green-banded leg towards the fault. Compare the numeric indicator reading with the ground rod reference number in the lower left corner of the display. If they are close, the fault is a major one. If the fault reading is 20 points or less than the reference, other faults almost surely exist and further searching is necessary to locate a major fault.

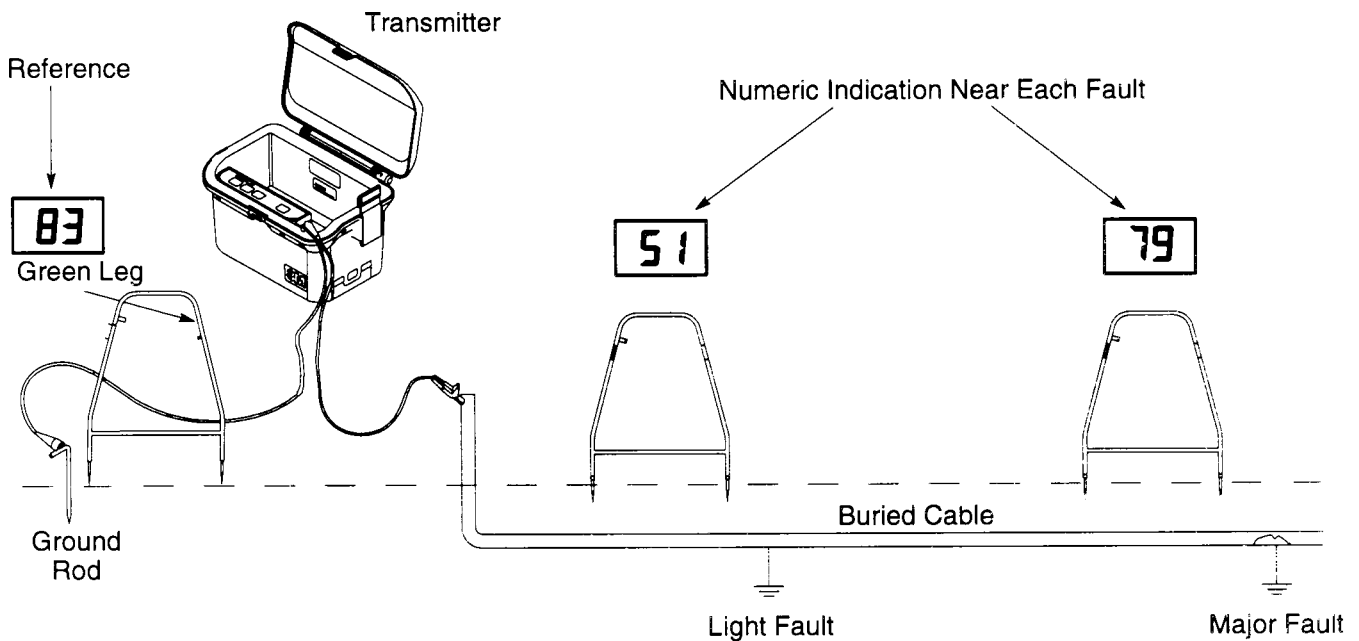

Multiple Faults

3. Locating Aerial Faults

- 3.1 Shorted pairs, crossed pairs, and grounds on aerial cables can be pinpointed using an exploring tone coil. To locate a fault with the exploring tone coil, use this procedure.
- 3.2 Determine if the fault is a short or cross or if a conductor is grounded to the shield. This will determine how the Transmitter is attached to the faulted conductors. If the resistance of the fault is greater than 1800 ohms as measured between the faulted conductors or between the conductor and ground, this method will not work.

If the fault is a shorted pair, connect the Red clip of the Direct Connect Transmitter Cable to tip and the Black to ring (or vice-versa) of the shorted pair.

If the fault is a cross (two pairs involved), connect the Red clip of the Direct Connect Transmitter Cable to the crossed conductor of one pair and the Black clip to the crossed conductor of the other pair.

If the fault is a ground, connect the Red clip of the Direct Connect Transmitter Cable to faulted conductor and the Black clip to ground.

- 3.3 Turn the Transmitter on and select the TONE mode and set the output level to the high.

Warning! *Potential for shock exists when handling connecting cables while the Transmitter is in the FAULT or TONE modes. Turn the transmitter off before handling connecting cables.*

- 3.4 Connect an exploring tone coil to the Receiver. Turn the Receiver on and select the tone mode. Select the 577 Hz frequency. Place the exploring tone coil on the cable and find a peak signal and press the GAIN key. Because of the twist or spiraling and the lay of conductors in the cable, there will be fluctuations in signal strength along the cable so be sure and listen for a peak before pressing the GAIN key. Adjust the speaker volume and listen for the tone while probing. Use headphones if needed in noisy locations.
- 3.5 Follow the cable with the exploring coil. The fault is located at the point where the signal stops or drops off sharply.

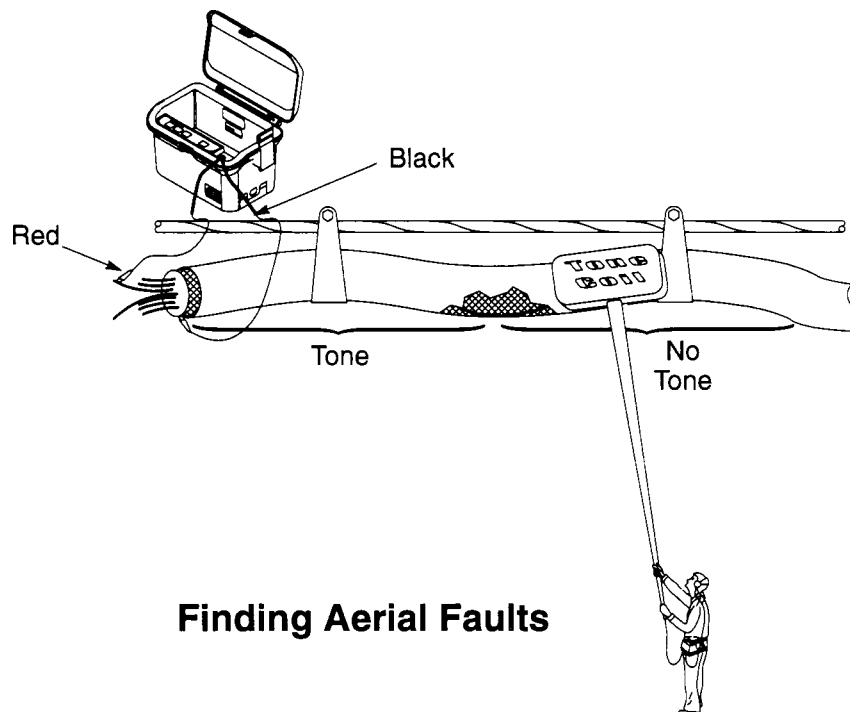

4. Locating Earth Faults Near the Meter Box

- 4.1 When the meter box is the access point for applying the Transmitter signal to locate a fault in secondary cable, be careful where the ground rod is placed. If the fault is very close (a few feet, at most), and the ground rod is also very close, it may be impossible to find the fault. The returning currents from the fault are so distorted by close ground rod placement that the earth contact frame cannot recognize the fault. A good practice is to always place the ground rod as far away from the meter box as possible and in line with the suspected cable path. However, it may not be possible to place the ground rod in line with the path because the house or structure supporting the meter is in the way.

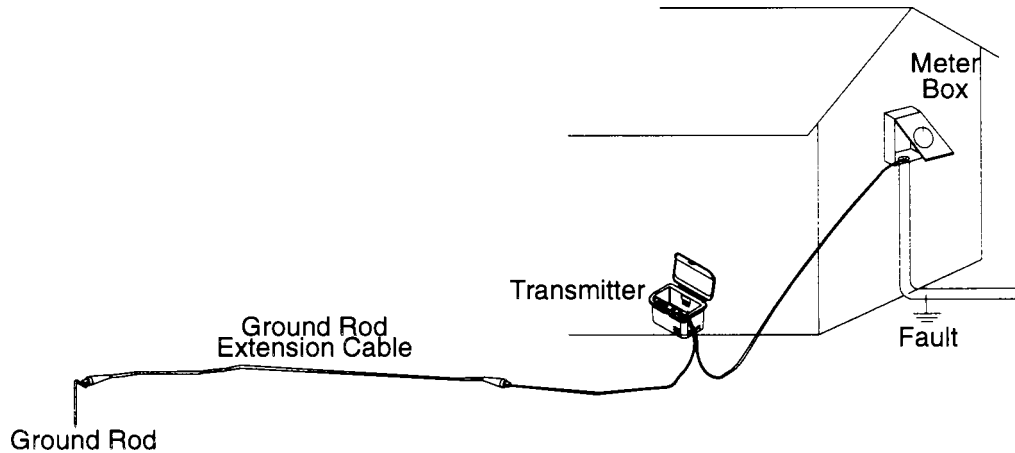

5. Locating Earth Faults in Secondary Cable

- 5.1 Locating a fault in secondary cable requires the Transmitter to send a current down the conductor to the damaged insulating jacket (the fault) and back to the ground rod. The operator uses the earth contact frame to find the point where the current stops traveling through the conductor and starts traveling through the earth. Since a grounded secondary neutral is also in the same trench with the faulted cable, it is a good practice to disconnect the neutral at both ends. If the neutral is not disconnected and it is also faulted, transmitter current could be prevented from traveling through the earth and the fault cannot be found, as in figure B.

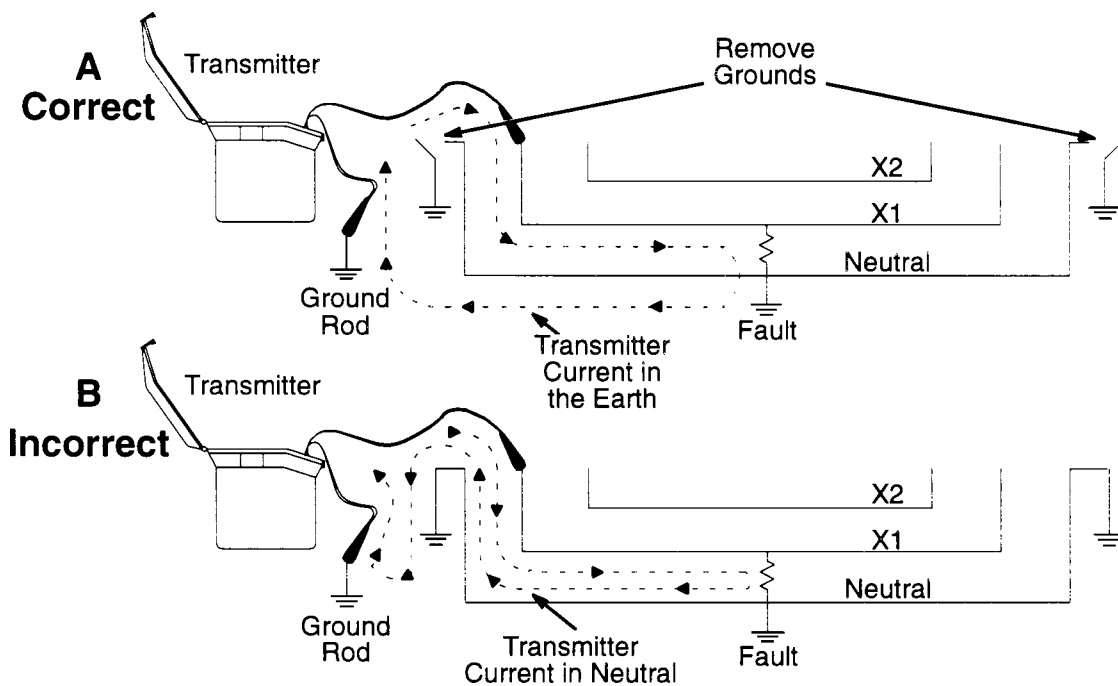

Section 7 Locating Active Duct Probes

1. Introduction

- 1.1 The 3M™ Active Duct Probe (ADP) is a self-contained, small, waterproof transmitter (sonde). It can be attached to a push-rod or pull-tape and inserted into a buried nonmetallic sewer, duct, drain, or pipe. A cable locator of the same frequency will find the exact surface location. There are several ADPs available from 3M. Models 3236, 3237, and 3238 Active Duct Probes transmit at frequencies detectable by 500A/573A cable locators. 3236 is for 500/573A, 3237 is for 500/573AP, and 3238 is for 500/573AC. Model 3229 transmits at 33 kHz and is detectable by either the 2210, 2250/2273, as well as the 500DL, 573DL, 2220L and 4420L.

2. Locating the Active Duct Probe

- 2.1 Unscrew the ADP cap. With the battery terminals up (toward the cap), connect the battery, then screw the cap back on and hand tighten only. Refer to Battery Replacement Figure.

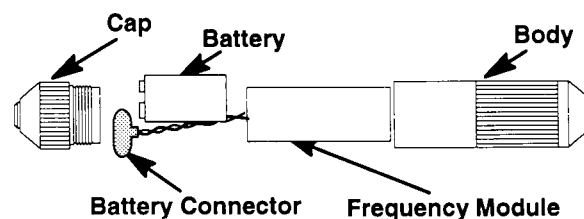

Battery Replacement

Note: When in doubt about the remaining battery life, use a fresh battery. If possible, always start a new job with a new battery.

- 2.2 The ADP cap has a female 1/4 X 20 thread and the body has a female 3/8X16 thread. Use these to attach the ADP to the snake, rodding tool, or pull tapes. Always use a lock nut.
- 2.3 Set the cable locator's receiver to the same frequency as the ADP. Set the receiver to PEAK mode. Make sure the ADP is working by placing the receiver 6 feet (2 m) from the sonde with the receiver handle perpendicular to the ADP. The receiver should pick up a clear signal.

Note: The perpendicular position of the receiver to the ADP is opposite of that used when tracing cables or pipes.

- 2.4 To locate the path of a nonmetallic conduit or pipe, use a rodding tool and insert the ADP about 3 feet (1 m) into the conduit or pipe. Locate the ADP and mark the spot. Push the ADP about two paces farther into the pipe. Relocate the ADP and mark the spot. Repeat this process until the path is fully mapped. To find the exact surface location follow these steps:

- 2.5 With the receiver handle perpendicular to the path, locate the ADP position by moving along the suspected path until a peak or maximum is found. Adjust the receiver gain as needed.

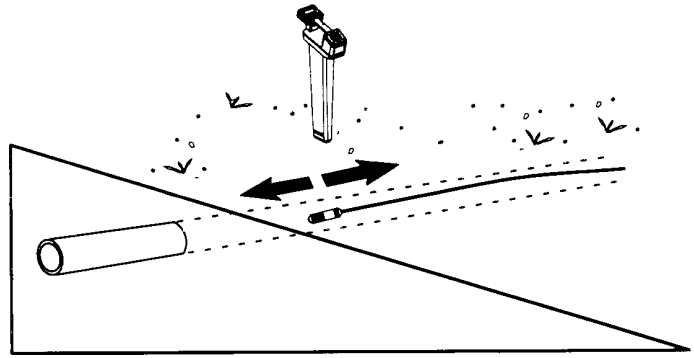

- 2.6 At the peak, rotate the receiver horizontally to maximize the signal. This ensures that the receiver handle is perpendicular to the path.

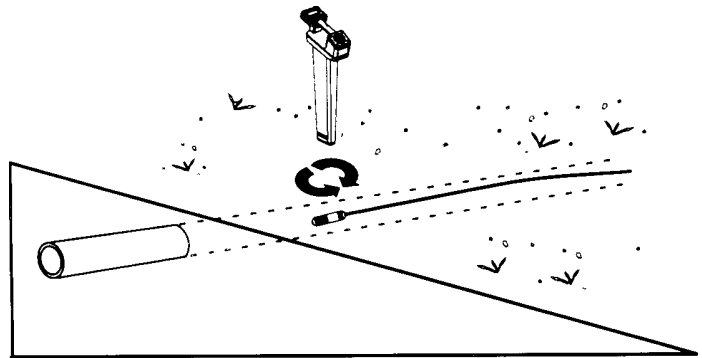

- 2.7 Next, move the receiver across the path searching for a peak. Mark the spot where the peak along the conduit path coincides with the peak across the path.

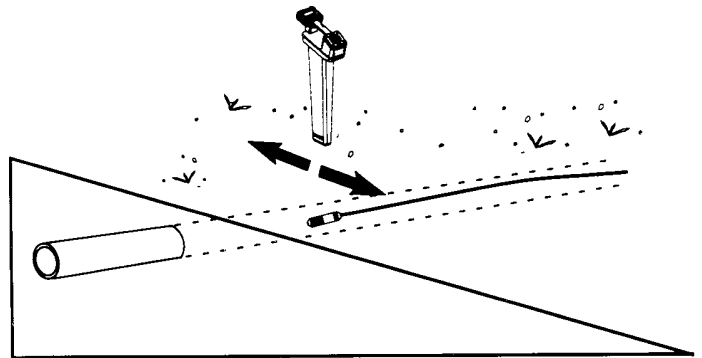

3. Determining the Depth of the ADP

- 3.1 Hold the receiver upright at ground level over the located ADP position maintaining the handle orientation perpendicular to the path. Press the depth key on the receiver. Dynatel 2250 and 2273 cable locators can read ADP depth directly. All other locators require that measurements be converted using the following procedure.
- 3.2 Due to the electromagnetic field produced by the ADP, the indicated depth is a signal depth which must be converted to the depth of the conduit containing the ADP. Below are two sets of tables (inches and centimeters) for specific Dynatel cable locators. Use the first set of tables to determine the ADP depth when using any of the 500DL/573DL Series, 2210, 2220L, or 4420L cable locators. Use the second set of tables for 500A/573A Series cable locators.

Depth Conversion Tables for Dynatel Cable Locators							
500DL/573DL Series, 2210, 2220L or 4420L							
INCHES				CENTIMETERS			
Measured Depth	ADP Depth	Measured Depth	ADP Depth	Measured Depth	ADP Depth	Measured Depth	ADP Depth
1"	1'5"	(1'8") 20"	6'7"	3 cm	43 cm	51 cm	201 cm
2"	1'9"	(1'10") 22"	7'1"	5 cm	53 cm	56 cm	216 cm
3"	2'0"	(2'0") 24"	7'7"	8 cm	61 cm	61 cm	231 cm
4"	2'4"	(2'3") 27"	8'4"	10 cm	71 cm	69 cm	254 cm
5"	2'7"	(2'6") 30"	9'1"	13 cm	79 cm	76 cm	277 cm
6"	2'10"	(2'9") 33"	9'10"	15 cm	86 cm	84 cm	300 cm
7"	3'2"	(3'0") 36"	10'7"	18 cm	97 cm	91 cm	323 cm
8"	3'5"	(3'3") 39"	11'5"	20 cm	104 cm	99 cm	348 cm
9"	3'8"	(3'6") 42"	12'2"	23 cm	112 cm	107 cm	371 cm
10"	3'11"	(3'9") 45"	12'11"	25 cm	119 cm	114 cm	394 cm
11"	4'3"	(4'0") 48"	13'8"	28 cm	130 cm	122 cm	417 cm
(1'0") 12"	4'6"	(4'4") 52"	14'8"	30 cm	137 cm	132 cm	447 cm
(1'2") 14"	5'0"	(4'8") 56"	15'8"	36 cm	152 cm	142 cm	478 cm
(1'4") 16"	5'6"	(5'0") 60"	16'8"	41 cm	168 cm	152 cm	508 cm
(1'6") 18"	6'0"	(5'4") 64"	17'8"	46 cm	183 cm	163 cm	538 cm

A. Determining ADP Depth with 500A/573A Cable Locators

1. Place the receiver on the ground over the located ADP position with the handle perpendicular to the path.
2. Turn mode switch to SET position. Adjust volume control for meter needle centered in the yellow area labeled SET.
3. Return mode switch to PEAK.
4. Raise the receiver straight up from the ground until the meter needle returns to the SET area of the meter.
5. Measure the distance from the bottom of the receiver to the ground. Find this number in the measured depth column of following tables, then read ADP depth.

Depth Conversion Tables for Dynatel Cable Locators							
500A/573A Series							
INCHES				CENTIMETERS			
Measured Depth	ADP Depth	Measured Depth	ADP Depth	Measured Depth	ADP Depth	Measured Depth	ADP Depth
1"	5"	(1'8") 20"	5'7"	3 cm	11 cm	55 cm	183 cm
2"	8"	(1'10") 22"	6'1"	5 cm	21 cm	60 cm	199 cm
3"	11"	(2'0") 24"	6'8"	8 cm	30 cm	65 cm	215 cm
4"	1'4"	(2'3") 27"	7'5"	10 cm	37 cm	70 cm	231 cm
5"	1'7"	(2'6") 30"	8'3"	13 cm	47 cm	75 cm	247 cm
6"	1'10"	(2'9") 33"	9'1"	15 cm	53 cm	80 cm	264 cm
7"	2'2"	(3'0") 36"	9'10"	18 cm	63 cm	85 cm	280 cm
8"	2'5"	(3'3") 39"	10'8"	20 cm	69 cm	90 cm	296 cm
9"	2'8"	(3'6") 42"	11'6"	23 cm	79 cm	100 cm	328 cm
10"	2'11"	(3'9") 45"	12'4"	25 cm	86 cm	110 cm	361 cm
11"	3'3"	(4'0") 48"	13'1"	30 cm	102 cm	120 cm	393 cm
(1'0") 12"	3'6"	(4'4") 52"	14'2"	35 cm	118 cm	130 cm	426 cm
(1'2") 14"	3'0"	(4'8") 56"	15'3"	40 cm	134 cm	140 cm	458 cm
(1'4") 16"	4'6"	(5'0") 60"	16'4"	45 cm	150 cm	150 cm	490 cm
(1'6") 18"	5'0"	(5'4") 64"	17'5"	50 cm	166 cm	160 cm	523 cm

4. Locating Blockage or Collapsed Ducts

- 4.1 Attach the ADP to a rodding tool and push it down the duct. In ducts with an inside diameter of 1.75 inches (45 mm), a bend with less than a 36 inch (92 cm) radius may obstruct the passage of the ADP. However, as the inside diameter of the duct increases to 2 inches (51 mm), the minimum bend radius becomes 12 inches (30.5 cm). Be aware that a bend in plastic ducts may cause a reduction in the inside diameter by making the duct oval even if the bend radius is large. This too will obstruct the passage of the ADP.
- 4.2 Do not wait until the rodding tool will not move to locate the ADP. It is best to periodically locate the ADP as it is pushed down the duct. Push the ADP farther into the pipe. Relocate the ADP and mark the spot. Repeat this process about every two paces until no more progress can be made as indicated by the ADP. When the ADP ceases to move, the blockage has been found.

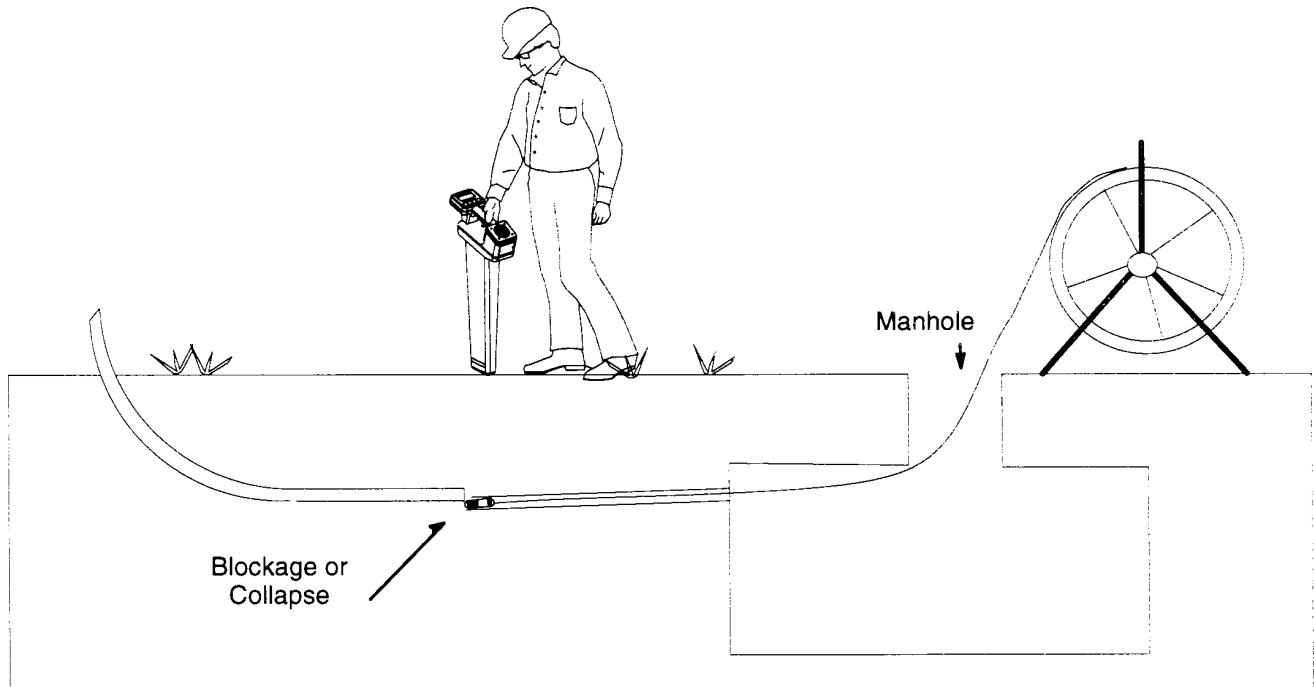

5. Locating Sewer Pipe Problems Using a Video Camera

- 5.1 When using video to inspect the inside of nonmetallic sewer pipe a repairable pipe problem is seen on the screen. An accurate surface location will save time and money. Also the video camera may become stuck and an accurate position of the expensive device will be needed for retrieval. Attach the ADP to the outside housing of the camera unit. Follow the progress of the camera by locating the attached ADP every few paces. This will require momentarily stopping the progress of the camera down the pipe. When a pipe anomaly is recognized, pinpoint the ADP and mark the spot.

6. Locating a Flushing Hose Nozzle

- 6.1 Attach the ADP to the flushing hose near the nozzle. Proceed to flush the nonmetallic pipe by inserting the hose and starting the fluid flow. As the hose moves into the pipe, locate the ADP every few paces. Obstructions the nozzle cannot pass are easily marked on the surface. If the hose becomes snagged and cannot be retrieved, a digging point on the surface can be found easily.

Important Notice

All statements, technical information and recommendations related to the Seller's products are based on information believed to be reliable, but the accuracy or completeness thereof is not guaranteed. Before utilizing the product, the user should determine the suitability of the product for its intended use. The user assumes all risks and liability whatsoever in connection with such use.

Any statements or recommendations of the Seller which are not contained in the Seller's current publications shall have no force or effect unless contained in an agreement signed by an authorized officer of the Seller. The statements contained herein are made in lieu of all warranties, expressed or implied, including but not limited to the implied warranties of merchantability and fitness for a particular purpose which warranties are hereby expressly disclaimed.

SELLER SHALL NOT BE LIABLE TO THE USER OR ANY OTHER PERSON UNDER ANY LEGAL THEORY, INCLUDING BUT NOT LIMITED TO NEGLIGENCE OR STRICT LIABILITY, FOR ANY INJURY OR FOR ANY DIRECT, INDIRECT, INCIDENTAL OR CONSEQUENTIAL DAMAGES SUSTAINED OR INCURRED BY REASON OF THE USE OF ANY OF THE SELLER'S PRODUCTS.

3M

Telecom Systems Division

6801 River Place Blvd.
Austin, TX 78726-9000
800/426-8688
<http://www.3M.com/telecom>



Recycled paper
50% pre-consumer
10% post-consumer

Litho in USA
© 3M 1998 80-6108-6216-3-C