



Distance Sensitive Left / Right Guidance™ Receiver Rev B

SALES AND TECHNICAL SUPPORT INFORMATION

Vivax-Metrotech Corporation
3251 Olcott Street,
Santa Clara, CA 95054, USA
Website : www.vivax-metrotech.com
Sales & Sales Support:
T/Free : +1-800-446-3392
Tel : +1-408-734-1400
Fax : +1-408-734-1415
Email : sales@vxmt.com

Application Support:
T/Free : +1-800-624-6210
Tel : +1-408-454-7159
Fax : +1-408-743-5597
Email : applications@vxmt.com

Service & Repairs:
T/Free : +1-800-638-7682
Tel : +1-408-962-9990
Fax : +1-408-734-1799
Email : service@vxmt.com

All Other Department:
T/Free : +1-877-330-1647
Tel : +1-408-734-3880
Fax : +1-408-962-9993

Canada
Vivax Canada Inc.
400 Esna Park Drive,
Unit 17, Markham,
Ontario, L3R 3K2, Canada
Tel : +1-289-846-3010
Website : www.vivax-metrotech.com
Email : CanadianSales@vxmt.com

Europe
SebaKMT
Seba Dynatronik
Mess-und Ortungstechnik GmbH
Dr.-Herbert-lann-Str. 6,
96148 Baunach, Germany.
Tel : +49-9544-680
Fax : +49-9544-2273
Website : www.sebakmt.com
Email : service@sebakmt.com

Australasia
SebaKMT AUS
Unit 1, 176 South Creek Road,
Cromer NSW 2009, Australia
Tel : +61-2-9972-9244
Fax : +61-2-9972-9433
Website : www.sebakmtaus.com
Email : sales@sebakmtaus.com
service@sebakmtaus.com

China
Leidi Utility Supply (Shanghai) Ltd.
Rm405 3rd Building No. 641, Tianshan Rd,
Shanghai, China 200336
Tel : +86-21-5187-3880
Fax : +86-21-5168-5880
Website : www.leidi.com
Email : info@leidi.cn





ISO 9001:2000 CERTIFIED

Metrotech has received ISO 9001:2000 Quality Management System Certification.

Metrotech adheres to the quality standard guidelines of ISO 9001:2000 and ensures quality in its design/development, production, installation, and servicing disciplines.

© Metrotech Corporation -2008

Metrotech Corporation
3251 Olcott Street
Santa Clara, CA 95054
USA

Tel: 1.800.446.3392; 1.408.734.1400
Fax: 1.408.734.1415
E-mail: sales@metrotech.com
Internet: www.metrotech.com



The instrument meets the following standards:

EMC-standard : 89/336/EEG (EEC)

Electromagnetic compatibility

Changing modification rule : 92/31/EEG

As well as:

Low voltage regulation : 73/23/EEG (EEC)

1 INTRODUCTION



The Metrotech Model *i5000* is a series of state-of-the-art utility line locators precisely designed with many powerful features to provide you with optimum information about your locate situation.

Included are a system overview, product specifications, quick start procedure for experienced users, and maintenance instructions.

2 GENERAL INFORMATION AND SAFETY

Symbols used in this manual

Important instructions concerning the protection of staff and equipment as well as technical safety within this document are labeled with one of the following symbols:

Symbol	Description
 WARNING	Indicates a potentially hazardous situation, which, if not avoided, could result in death or serious injury.
 CAUTION	Indicates a potentially hazardous situation, which, if not avoided, may result in minor or moderate injury or material damage.
	Notes have important information and useful tips on the operation of your equipment. Non-observance may result in incorrect measurement results.

Operating personnel

Metrotech utility line locators are intended for use by utility and contractor professionals. Safety hazards for underground utility access areas include electrical shock, explosive gases, and toxic fumes as well as potential influence on communications and control systems such as traffic control and railroad crossings.

Repair and maintenance

Repairs and service must only be done by Metrotech Corporation or authorized service departments of Metrotech Corporation.

3 SAFETY PRECAUTIONS

This manual contains basic advice for the installation and operation of Metrotech Utility Line Locators and accessories. The manufacturer is not liable for damage to material or humans due to non-observance of the instructions and safety advice provided in this manual. Therefore, this manual should be provided and reviewed by all personnel associated with the line locating equipment.

Observed Safety Practices

Familiarize yourself with all required safety practices of the local utility company, or other owner of the plant before entering an access area, or connecting a Metrotech transmitter.

Ensure that the line is de-energized and out of service, before connecting the transmitter directly to any conductor. NEVER make a direct connection to a live power cable.

Follow the appropriate safety procedures to avoid the risk of injury if using a clamp on energized electrical or control lines.

Pay special attention when using a locator in high traffic areas.

Intended application

Safe operation is only realized when using the equipment for its intended purpose. Using the equipment for other purposes may lead to human danger and equipment damage.

The limits described under the technical data section may not be exceeded.

Malfunctioning Behavior

The equipment may only be used when working properly. When irregularities or malfunctions appear that cannot be solved consulting this manual, the equipment must immediately be put out of operation and marked as not functional. Metrotech Corporation must be contacted for technical support and/or service. The instrument may only be operated when the malfunction is resolved.

FIVE SAFETY RULES

The five safety rules must always be followed when working with High Voltage (HV):

De-energize

Protect against re-energizing

Confirm absence of voltage

Ground and short-circuit

Cover up or bar-off neighboring energized parts



Fire fighting in electrical installations:

Recommended extinguishing agent: carbon dioxide (CO₂)

Carbon dioxide is electrically non conductive and does not leave residue. It is safe to use in energized facilities as long as the minimum distances are observed.

It is essential to observe the safety instruction on the extinguishing agent.



Dangers when operating with HV:

Special safety attention is needed when operating HV facilities, especially non-stationary equipment. The regulations VDE 0104 about setting up and operation of electric test equipment, i.e. the corresponding EN 50191 as well as country-specific regulations and standards must be observed.

Safety installations may not be by-passed nor deactivated.

Operation requires a minimum two people whereas the second person must be able to activate the emergency switch in case of danger.

To avoid hazardous electric charges of metallic parts in the vicinity, all metallic parts must be grounded.

To avoid drawing dangerous arcs, switching should only be done in a de-energized condition.

The equipment and all accessories must be connected according to applicable standards VDE, EN or DIN as well as country-specific regulations.

1 Quick Start Guide for the Experience User

1) Turn the Receiver ON

Push the Power ON button to switch on the *i5000* receiver. The Metrotech welcome screen is displayed for a few seconds. This screen also displays the model number and the software revision number.



Figure 1-1 *i5000* Welcome Screen

The receiver display then reverts to the main locating screen. The receiver is ready to perform locates.

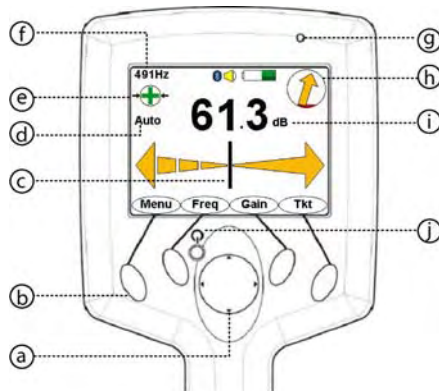

Figure 1-2 Line Locate Operational Interface

Display Legend	
a.	4-Way Navigation Button
b.	Soft Keys
c.	Distance Sensitive Left/Right Guidance™ Needle
d.	Auto or Manual Gain
e.	Signal Select™
f.	Active Frequency
g.	Bluetooth® ON
h.	Guidance Compass™
i.	Numerical Field Signal Strength
j.	Power ON Button

2) Select the Frequency

Press the **Freq** soft key to select the desired locating frequency. If the receiver detects a transmitter signal, the numerical field strength and the left/right guidance needle respond to movements of the receiver.

3) Determine the Center Line Position

Use the field strength readings and the left/right guidance needle to determine the centerline position of the target line being located.

4) Observe the Guidance Compass

The guidance compass indicator provides additional information about the locate:

- The direction of the signal is indicated by the orientation of the orange arrow inside the guidance compass indicator. A FORWARD pointing arrow indicates that the receiver detects a signal flowing away from the transmitter. A DOWNWARD pointing arrow means that the signal is a return signal flowing back towards the transmitter.
- Changes in the direction of the line relative to the orientation of the receiver are indicated by the signal direction arrow moving away from the North or South position.
- The presence of bleedover signals is indicated by the RED color filling the inside of the guidance compass indicator.

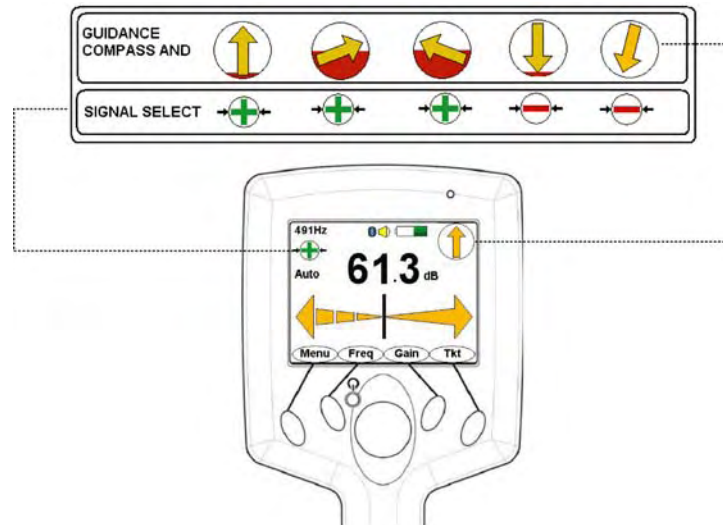

Figure 1-3 Operational Interface

5) Perform Depth and Current Measurements

Press the lower section of the navigation button to compute a depth and current measurement. Depth and current estimates are displayed. Thereafter, the receiver returns to the locating mode.

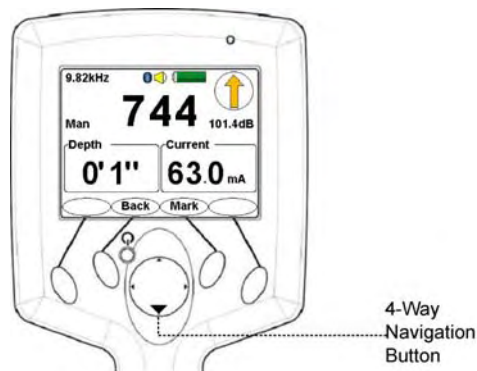









Figure 1-4 Depth & Current Measurement Screen

2 Display Elements

The color graphical display shows intuitive icons used to aid in accurate locating by the user.

Display Icon		Description
Battery Level		Displayed as a continuous level from a full 100% charge to 0%.
Signal Select™		Displayed when activated in direct (conductive) connection or Signal Select Clamp mode. This icon alerts the user if the receiver detects Signal Select modulation.
Guidance Compass™		A single graphical icon that implements three tools aiding locating accuracy – signal select, distortion alert, and line guidance.
Distortion Alert™		The Distortion Alert, displayed as a red-filling or emptying circle, denotes when a non-ideal magnetic field is detected.
Frequency	982Hz	The active frequency, or the passive band name (power or RF), is always displayed on the top left of the display.
Locate Mode	Sonde	In Sonde locate mode, the active mode is displayed on the top left of the display. Otherwise, line locate mode is active.
Signal Gain Mode	Auto Man	Indicates Auto or Manual signal strength mode. In auto mode, signal strength is measured in decibels (dB). The auto gain mode can be readjusted pressing the 4-way navigation button up. Manual gain is displayed in a linear scale from 000 to 999. The manual gain can be increased or decreased by pressing the 4-way navigation button right or left, respectively.
Speaker Volume		Indicates the speaker volume setting - from off to high.
Bluetooth		Indicates an active Bluetooth connection.
RS232		Appears when a host serial cable is connected to i5000 receiver.
GPS		Indicates the receiver can receive signals from 3 or more satellites (optional).

1 *i5000* Receiver System Overview

The *i5000* Utility Locating System brings the power and flexibility of digital signal processing (DSP) to Metrotech’s long line of sensitive and easy to use utility line locators. Two main interfaces are available to operate all the key features of the receiver.

1.1 Top View

The *i5000* receiver includes a colorful graphical display, a 4-way navigation button, and four soft keys for operation and setup modes. A separate Power ON button, located near the navigation button, provides easy access to activate power. See figure below.

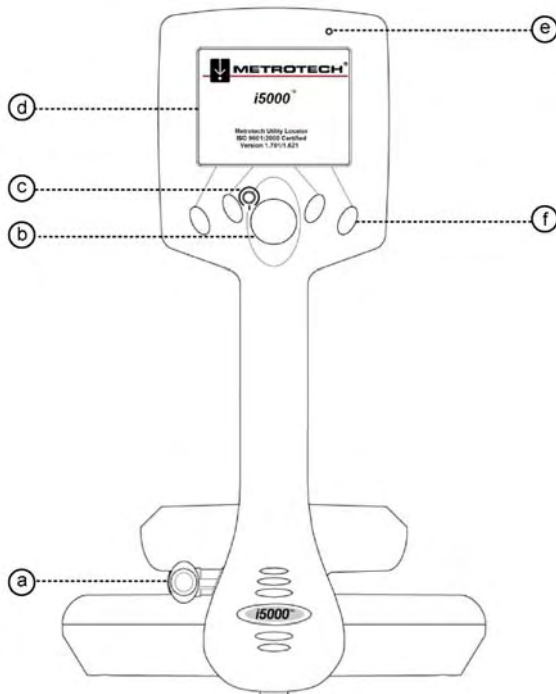

Top View Legend	
a.	GPS antenna (optional)
b.	4-way Navigation Button
c.	Power ON Button
d.	Operational Interface
e.	Bluetooth® Transmission ON Indicator
f.	Soft Keys

Figure 1-1 *i5000* Top View

1.1.1 Operational Interface

The *i5000* receiver operational screen is a ¼ VGA bright color graphical display. Two screens are displayed to the user – locate mode and measurement.

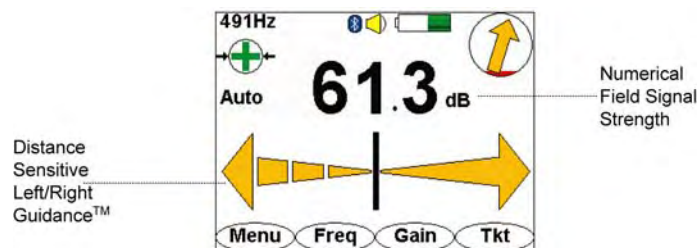

Figure 1-2 Locate Mode Interface

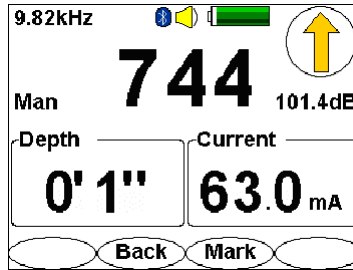

Figure 1-3 Measurement Interface

1.1.1.1 Display Elements

The color graphical display shows intuitive icons used to aid in accurate locating by the user.

Display Icon		Description
Battery Level		Displayed as a continuous level from a full 100% charge to 0%.
Signal Select™		Displayed when activated in direct (conductive) connection or Signal Select Clamp mode. This icon alerts the user if the receiver detects Signal Select modulation.
Guidance Compass™		A single graphical icon that implements three tools aiding locating accuracy – signal select, distortion alert, and line guidance.
Distortion Alert™		The Distortion Alert, displayed as a red-filling or emptying circle, denotes when a non-ideal magnetic field is detected.
Frequency	982Hz	The active frequency, or the passive band name (power or RF), is always displayed on the top left of the display.
Locate Mode	Sonde	In Sonde locate mode, the active mode is displayed on the top left of the display. Otherwise, line locate mode is active.
Signal Gain Mode	Auto Man	Indicates Auto or Manual signal strength mode. In auto mode, signal strength is measured in decibels (dB). The auto gain mode can be readjusted pressing the 4-way navigation button up. Manual gain is displayed in a linear scale from 000 to 999. The manual gain can be increased or decreased by pressing the 4-way navigation button right or left, respectively.
Speaker Volume		Indicates the speaker volume setting - from off to high.
Bluetooth		Indicates an active Bluetooth connection.
RS232		Appears when a host serial cable is connected to <i>i5000</i> receiver.
GPS		Indicates the receiver can receive signals from 3 or more satellites (optional).

1.2 Side Views

The *i5000* is equipped with a smart accessory connector and battery pack, accessible from the receiver's right side panel.

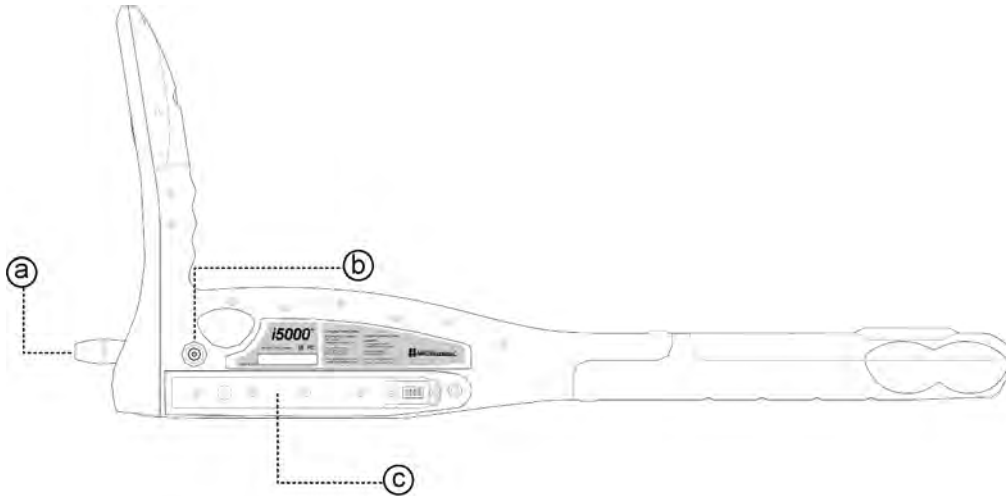

Figure 1-4 i5000 Side View

Side View Legend	
a.	GPS antenna (optional)
b.	Smart Connector
c.	Battery Pack Receptacle

1.2.1 Battery Pack

The *i5000* receiver is powered by a high-capacity Li-ion rechargeable or alkaline battery pack. See figure below.

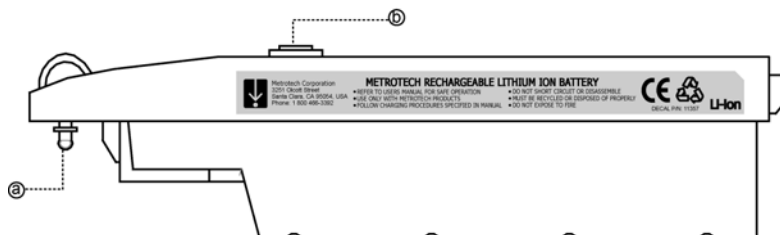

Figure 1-5 Li-ion Battery Pack

Battery Pack Legend	
a.	Battery Lock
b.	Recharging Receptacle

1.2.1.1 Recharging the Battery

The battery pack can be recharged while seated inside the receiver body. To recharge the battery pack:

1. Make sure recharging of the receiver battery occurs at room temperature. Charging the battery at low and high ambient temperature will affect how many charge cycles the battery can withstand and might cause other battery damage.



Excess heat can damage batteries, causing a rupture or ignition. Do not place batteries near fire, heat, or in direct sunshine.

2. Attach the *i5000* mains power supply to the charging jack of the Li-ion battery pack.
3. Plug the power supply into the electrical outlet.
4. The recharging time for a fully discharged battery pack is approximately 8 hrs.

The battery pack can also be recharged via the 12VDC vehicle adapter.



Batteries contain hazardous material that may be harmful to the environment. Dispose used batteries sensibly. Follow local recycling guidelines for disposal of similar material.

1 *i5000* Receiver Technical Specifications

Active Frequencies (Hz)	491, 982, 8.44k, 9.82k, 35k, 82k, 83k (North America) 491, 512, 577, 640, 982, 8k, 8.44k, 9.82k, 35k, 65.5k, 82k, 83k
Passive Frequencies (Hz)	50, 60, 100, 120, RF (14k-21k) Extended and special frequency sets available
Depth Display Accuracy	0-10ft: +/- (5%+2") under ideal field conditions 10-20ft: +/- 10% under ideal field conditions
Depth Range	Maximum 20ft (600 cm)
Gain Adjustment	Automatic & manual with pushbutton centering
Controls	On/off, four-way navigation key and soft keys
Display Indicators	Frequency, GPS, audio volume, battery condition, Guidance Compass™, Distortion Alert™, Signal Select™, signal strength, Distance Sensitive Left/Right Guidance™, menu softkey, frequency softkey, gain softkey, shortcut softkey
Line ID	Signal Select, Guidance Compass, Distortion Alert
Display	¼ VGA Bright Color
Antenna	Peak Null or Distance Sensitive Left/Right Guidance
Communications	Bluetooth®
Data Acquisition	GPS, internal data logging memory
Operating Temperature	-4°F to +122°F (-20°C to +50°C)
Battery Type	Li-ion rechargeable 9 AA Alkaline
Battery Life	30 hours continuous
Battery Check	Continuous display
Dimensions	8 ¼" W x 13 ¼" H x 29" L (21.0cm x 33.7 cm x 74.3cm)
Weight	4.9 lb (2.2 kg)
Regulatory Compliance	FCC, CE
Environmental	IP54

2 Options

Data logging
GPS antenna
MyLocator™ data warehousing and analysis service

3 Accessories

3.1 Standard

Li-ion rechargeable battery pack
AC power adapter for rechargeable battery
Operations manual
Hard carrying case

3.2 Optional

Serial interface cable
12VDC vehicle adapter rechargeable battery
Soft carrying cases
Search coil

1 *i5000* Menu System

The receiver's menu system includes six (6) selectable menus for configuring the *i5000*. Press the <Menu> soft key from the operational interface to access the main menu.

2 Main Menu

To access the main menu, press the <Menu> soft key from the operational interface.

The desired menu is selected using the 4-way navigation button. Press the button up/down/left/right to select the desired menu option. The selected menu is highlighted on the interface as well as labeled at the top of the display.

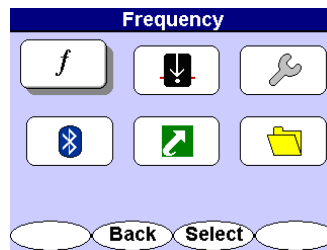

Figure 2-1 Main Menu Selection

2.1 Frequency Menu

The Frequency menu activates or deactivates any of the available receiver frequencies. Depending on the configuration of your *i5000* receiver, the following frequencies may be available. See the table below for the available frequencies.

Region	Base Frequency Set (Hz)
North America	491, 982, 8.44k, 9.82k, 35.4k, 82k, 83k, 50, 60, 100, 120, RF
International	491, 512, 577, 640, 982, 8k, 8.44k, 9.82k, 35.4k, 65.6k, 82k, 83k, 50, 60, 100, 120, RF

To allow easier navigation, the available frequencies are organized into several groups. To access the frequency menu, use the 4-way navigation button to highlight *f*. The chosen menu is also labeled at the top of the menu screen.

Press the <Select> soft key to open the desired menu screen. Press <Back> to return to the operational interface. Use the 4-way navigation button to select another menu.

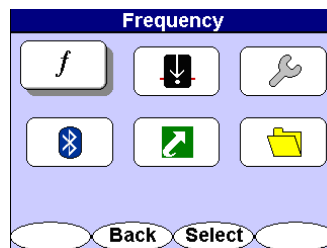

Figure 2-2 Frequency Menu Selection

2.1.1 Low Frequency

Low frequencies are interface frequencies below 1kHz.

Use the 4-way navigation button to move up and down the frequency list. Use the 4-way navigation button to move right to highlight the frequencies. Press the <Select> soft key to activate or deactivate specific or all frequencies.

Deactivating frequencies does not permanently remove these from the *i5000* receiver. Access the frequency menu to reactivate them.

Activated frequencies can be selected from the operational interface by pressing the <Freq> soft key. Selecting fewer frequencies allows faster toggling between frequencies from the operational interface.

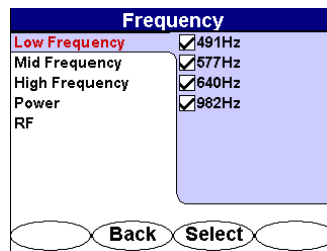

Figure 2-3 Low Frequency Selection Screen in Frequency Menu

2.1.2 Mid Frequency

Mid frequencies are in the range between 1kHz and 10kHz.

Use the 4-way navigation button to move up and down the frequency list. Use the 4-way navigation button to move right to highlight the frequencies. Press the <Select> soft key to activate or deactivate specific or all frequencies.

Deactivating frequencies does not permanently remove these from the *i5000* receiver. Access the frequency menu to reactivate them.

Activated frequencies can be selected from the operational interface by pressing the <Freq> soft key. Selecting fewer frequencies allows faster toggling between frequencies from the operational interface.

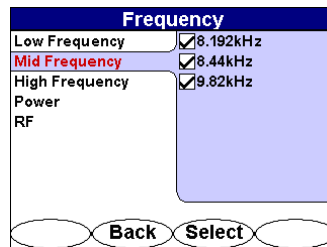

Figure 2-4 Mid Frequency Selection Screen in Frequency Menu

2.1.3 High Frequency

High frequencies are those above 10kHz.

Use the 4-way navigation button to move up and down the frequency list. Use the 4-way navigation button to move right to highlight the frequencies. Press the <Select> soft key to activate or deactivate specific or all frequencies.

Deactivating frequencies does not permanently remove these from the *i5000* receiver. Access the frequency menu to reactivate them.

Activated frequencies can be selected from the operational interface by pressing the <Freq> soft key. Selecting fewer frequencies allows faster toggling between frequencies from the operational interface.

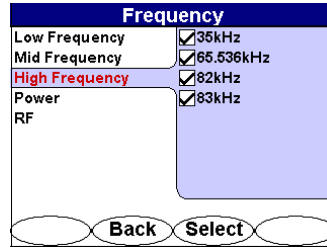

Figure 2-5 High Frequency Selection Screen in Frequency Menu

2.1.4 Power

The Power menu allows switching between 50Hz and 100Hz passive locating modes.

Use the 4-way navigation button to move up and down the frequency list. Use the 4-way navigation button to move right to highlight the frequencies. Press the <Select> soft key to activate or deactivate specific or all frequencies.

Deactivating frequencies does not permanently remove these from the *i5000* receiver. Access the frequency menu to reactivate them.

Activated frequencies can be selected from the operational interface by pressing the <Freq> soft key. Selecting fewer frequencies allows faster toggling between frequencies from the operational interface.

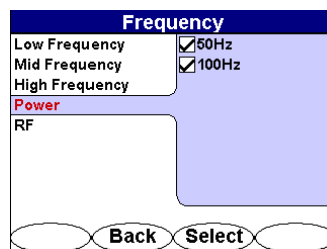

Figure 2-6 Power Frequency Selection Screen in Frequency Menu

2.1.5 RF

The RF menu allows the activation or deactivation of the RF passive locating capability of the *i5000* receiver.

Use the 4-way navigation button to move up and down the frequency list. Use the 4-way navigation button to move right to highlight the frequency. Press the <Select> soft key to activate or deactivate specific or all frequencies.

Deactivating frequencies does not permanently remove these from the *i5000* receiver. Access the frequency menu to reactivate them.

Activated frequencies can be selected from the operational interface by pressing the <Freq> soft key. Selecting fewer frequencies allows faster toggling between frequencies from the operational interface.

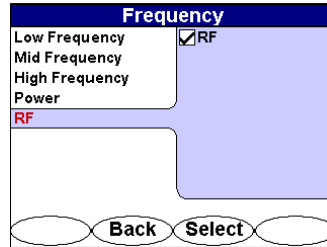

Figure 2-7 RF Selection Screen in Frequency Menu

2.2 Mode Menu

The *i5000* receiver has two locate modes - line locate and sonde locate.

To access the locate mode menu, use the 4-way navigation button to highlight **Mode**. The chosen menu is labeled at the top of the menu screen.

Press the <Select> soft key to open the desired menu screen. Press <Back> to return to the operational interface. Use the 4-way navigation button to select another menu.

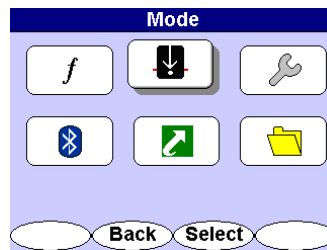

Figure 2-8 Mode Menu Selection

2.2.1 Line Locate

Line Locate mode is used to trace the cable using a rack-mount transmitter signal or a portable transmitter signal.

To access the line locate mode, use the 4-way navigation button to select the desired mode.

Press the <Select> soft key to select the desired mode. Press <Back> to return to the previous interface.

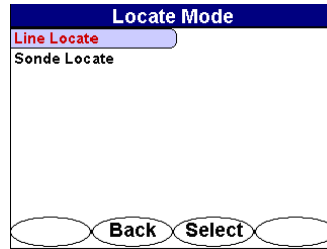

Figure 2-9 Line Locate Selection Screen in Mode Menu

2.2.2 Sonde Locate

In Sonde Locate mode, the receiver automatically adjusts its depth calculation algorithms to reflect the differences between a line radiating a transmitter signal and the signal generated by a sonde transmitter.

To access the sonde locate mode, use the 4-way navigation button to select the desired mode.

Press the <Select> soft key to select the desired mode. Press <Back> to return to the previous interface.

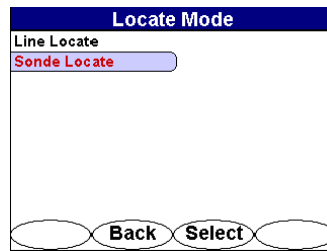

Figure 2-10 Sonde Locate Selection Screen in Mode Menu

2.3 Settings Menu

The Settings menu offers the following menu selections:

- Personalize
- Audio
- Initial Setup
- Display Clock
- Preset State
- About

To access the settings menu, use the 4-way navigation button to highlight **Settings**. The chosen menu is labeled at the top of the menu screen.

Press the <Select> soft key to open the desired menu screen. Press <Back> to return to the operational interface. Use the 4-way navigation button to select another menu.

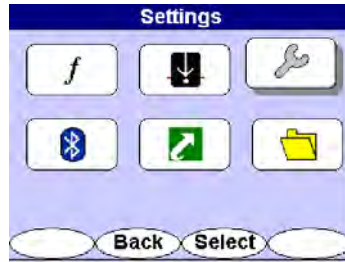

Figure 2-11 Settings Menu Selection

2.3.1 Personalize

The operator can control certain user interface elements of the *i5000* receiver. Available choices are:

- Distortion Number
- Distortion Graph
- Signal Select
- Guidance Compass

Use the 4-way navigation button to move up and down the settings list. Use the 4-way navigation button to move right to highlight the personalized settings. Press the <Select> soft key to activate or deactivate specific or all personalized settings. Press <Back> to return to the previous menu.

Access the settings menu to reactivate them.

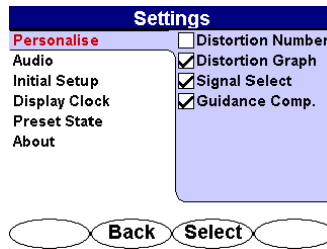

Figure 2-12 Personalize Selection Screen in Settings Menu

2.3.2 Audio

The Audio menu controls the *i5000* receiver audio output characteristics.

Use the 4-way navigation button to move up and down the settings list. Use the 4-way navigation button to move right and highlight the audio options. Press the <Select> soft key to toggle through the different speaker volume settings – from OFF to High.

After selecting the desired speaker volume, use the 4-way navigation button to highlight the **Sound** option. Use the <Select> button to toggle through the available choices - LR, AM and None. The Sound options are:

- LR (Left/Right audio guidance)
- AM (Amplitude modulated audio mode mapped to Peak signal strength)
- None (Deactivates speaker output related to Left/Right audio guidance or Peak signal strength but keeps Key-Sound interface)

Use the 4-way navigation button to highlight the **Key-Sound** option. Highlighting the Key-Sound option switches the key sound ON or OFF. In the ON mode, the speaker emits a short beep any time a key is pressed even when the speaker volume setting is OFF.

Press the <Select> button between ON and OFF. Press <Back> to return to the previous menu.

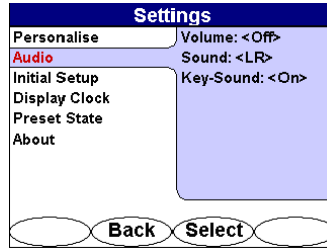

Figure 2-13 Audio Selection in Settings Menu

2.3.3 Initial Setup

The Initial Setup section of the Settings menu controls the following receiver features:

- Backlight
- Units
- Auto-Off
- Last Frequency
- Language

Use the 4-way navigation button to move up and down the settings list. Use the 4-way navigation button to move right and highlight the **Initial Setup** option. Use the 4-way navigation button to move right and highlight the setup options.

The **Backlight** has three selectable options – 60 seconds ON prior to turning OFF, always ON, or always OFF. If the 60s option is selected, any key-push returns the backlight on for 60s should it have been timed out. Press the <Select> soft key to toggle through the different backlight options.

The **Units** menu item controls the depth readout format of the receiver. Two options are available – US and Metric. The US setting displays depth in feet and inches. The Metric setting provides depth readout in cm. Press the <Select> soft key to toggle between the options.

The factory default setting for the **Auto-Off** option is for the receiver to automatically power down after five minutes of inactivity. Changing the setting to ON forces the receiver to stay ON until the Power ON button is pressed. Press the <Select> soft key to toggle through the options

The receiver can be set to automatically select a preferred frequency at power up or to the last frequency used. The factory default setting is Last Frequency Used. Press the <Select> soft key to toggle through the options.

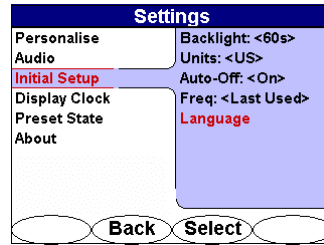

Figure 2-14 Initial Settings Selection in Settings Menu

2.3.3.1 Language

The *i5000* supports various languages – English, Spanish, French, and German. To reset the menu system to the desired language, use the 4-way navigation button to highlight the **Language** option. Press the <Select> soft key to activate the desired language. Press the <Back> soft key to return to the previous interface.

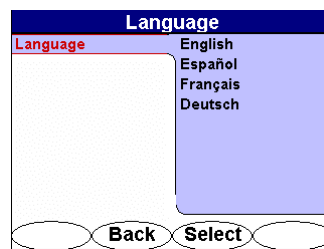

Figure 2-15 Language Selection Menu

2.3.4 Display Clock – Optional GPS Clock Time

The global positioning system (GPS) Clock Time is displayed in Greenwich Mean Time (GMT). To display the GPS clock time, use the 4-way navigation button to move up and down the settings list. Highlight **Display Clock** and press the <Select> soft key.

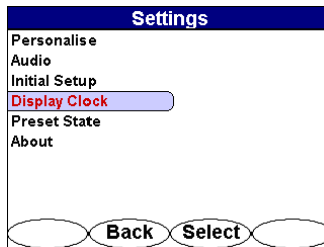

Figure 2-16 Display Clock Selection in Settings Menu

The GPS time is displayed. Press the <Back> soft key to return to the previous screen.

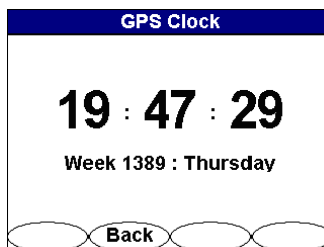

Figure 2-17 GPS Clock Display

2.3.5 Preset State

The Preset State menu option allows the operator to restore the *i5000* receiver user interface configuration to factory default settings for all menu selections in just one simple operation. Selecting the Preset State function does not result in any loss of receiver capability, the choice of available frequencies, or the loss of any data stored in the data logging memory.

Use the 4-way navigation button to move up and down the settings list. Press the <Select> soft key to choose the Preset State. Press the <Back> soft key to return to the previous interface.

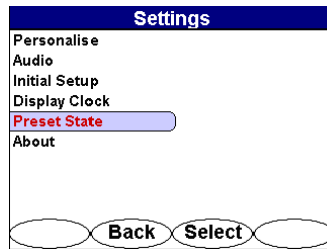

Figure 2-18 Preset State Selection in Settings Menu

After selecting the Preset State function, the following screen appears to prevent accidental resetting to the factory default settings.

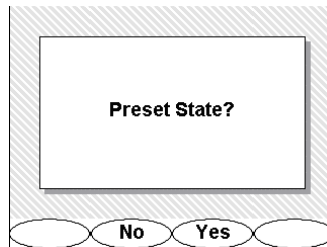

Figure 2-19 Preset State Option in Preset State Menu

Press the <No> or <Yes> soft key to select the desired preset state.

2.3.6 About

The About screen displays important information about the *i5000* receiver's software and hardware configuration.

Use the 4-way navigation button to move up and down the settings list. Press the <Select> soft key to choose the **About** option. Press the <Back> soft key to return to the previous interface.

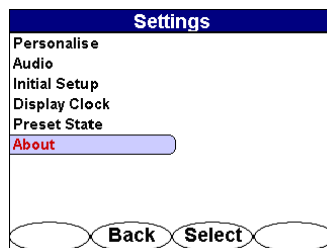

Figure 2-20 About Selection in Settings Menu

The information provided is useful when communicating with Metrotech's technical support organization. Press any soft key to return to the previous interface.

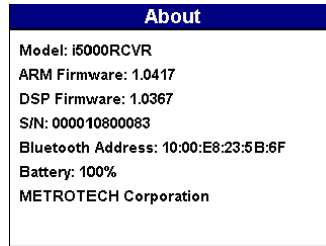

Figure 2-21 About Display Information in Settings Menu

2.4 Bluetooth Menu

The Bluetooth wireless connection allows Bluetooth-enabled devices to communicate with the *i5000* receiver. Data and digital photos can be saved in memory and transferred via Bluetooth wireless communication to laptop computers or PCs. The reverse is also available - locate ticket information and digital photos may be loaded into the *i5000* memory. An example is the downloading of locate tickets into memory and the closing of these tickets with the retransmission of detailed locate information and digital photos.

To access the Bluetooth menu, use the 4-way navigation button to highlight the Bluetooth icon. The chosen menu is also labeled at the top of the menu screen.

Press the <Select> soft key to open the desired menu screen. Press <Back> to return to the operational interface. Use the 4-way navigation button to select another menu.

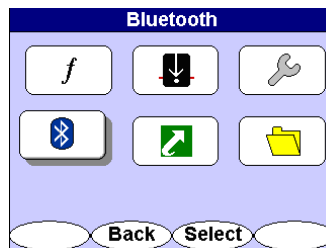

Figure 2-22 Bluetooth Selection in Main Menu

2.4.1 Discoverable Selection

To open a connection with other Bluetooth enabled devices, the receiver must be set to Discoverable. This places the *i5000* receiver open to connections with other Bluetooth devices for 60 seconds. During this period, the *i5000* receiver will identify the Bluetooth device.

Use the 4-way navigation button to move up and down the Bluetooth Settings list. Press the <Select> soft key to choose the **Discoverable** option. Press the <Back> soft key to return to the previous interface.

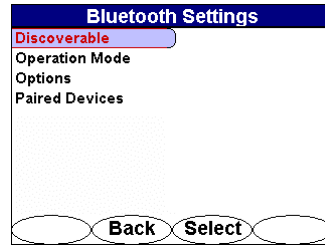

Figure 2-23 Discoverable Option in Bluetooth Menu

2.4.2 Operation Mode

The operation mode sets the data transmission selection – Bluetooth, RS232, or either option. Selecting Auto allows receiver connections via the RS232 cable or via Bluetooth. If the RS232 cable is connected, Bluetooth is not available. Selecting ON allows connection with Bluetooth only. Selecting OFF turns the Bluetooth feature off. The default setting is Auto.

Use the 4-way navigation button to move up and down the Bluetooth Settings list. Use the 4-way navigation button to move right and highlight the options. Press the <Select> soft key to choose the option. Press the <Back> soft key to return to the previous interface.

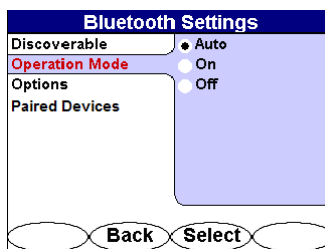

Figure 2-24 Operation Mode in Bluetooth Settings Menu

2.4.3 Options

Selecting Factory Preset resets certain internal Bluetooth settings to factory defaults.

Make sure the *i5000* receiver Bluetooth Setting is in the OFF position before entering any telecommunications central office or other telecommunications data transmission infrastructure.

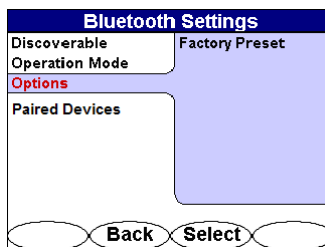

Figure 2-25 Options in Bluetooth Settings Menu

2.4.4 Paired Devices

i5000 transmitters are equipped with Bluetooth transmission capabilities. The paired devices menu allows the user to mate up to six transmitters to a single receiver. If a receiver is within 30 ft. (9 m) of a transmitter and Bluetooth transmission is ON for both instruments, the receiver logs the output power conditions and active frequencies every 30 sec. Logged data is stored in the

receiver memory until the receiver is synchronized and uploaded to Metrotech's MyLocator web service. The blue LED emits during active transmission. Use the 4-way navigation button to move up and down the Bluetooth Settings list. Use the 4-way navigation button to move right and highlight the options. Press the <Select> soft key to choose the option. Press the <Back> soft key to return to the previous interface.

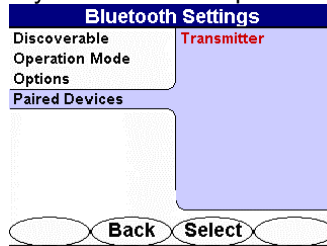

Figure 2-26 Paired Devices in Bluetooth Settings Menu

2.4.4.1 Pairing a Transmitter and Receiver

To pair a transmitter and receiver, make sure both instruments have the Bluetooth feature ON. Press the <Select> soft key to initiate discovery of the transmitter. Press the <Back> soft key to return to the previous interface.

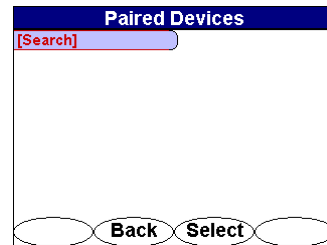

Figure 2-27 Search Feature in Paired Devices Menu

Upon completion of the transmitter discovery, the receiver displays the paired transmitter. The last four digits of each transmitter denotes the unique identity of each paired unit.

To remove a paired transmitter, use the 4-way navigation button to highlight the desired unit. Press the <Clear> soft key to erase a paired transmitter from the list.

To remove all paired devices, use the 4-way navigation button to highlight **Clear all devices**. Press the <Clear> soft key to erase all paired devices.

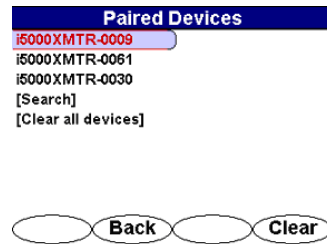

Figure 2-28 Transmitter List in Paired Devices Menu

2.5 Shortcuts Menu

Shortcuts set the right-most soft key to a selection of features including Volume adjustment, Backlight Power, and Ticket Management.

To access the shortcuts menu, use the 4-way navigation button to highlight **Shortcuts**. The chosen menu is labeled at the top of the menu screen.

Press the <Select> soft key to open the desired menu screen. Press <Back> to return to the operational interface. Use the 4-way navigation button to select another menu.

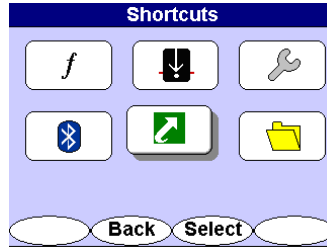

Figure 2-29 Shortcuts Selection in Main Menu

Use the 4-way navigation button to move up and down the Shortcuts list. Press the <Select> soft key to activate or deactivate the options. Press the <Back> soft key to return to the previous interface.

Selecting Adjust Volume places the shortcut to Adjust Volume (VOL).

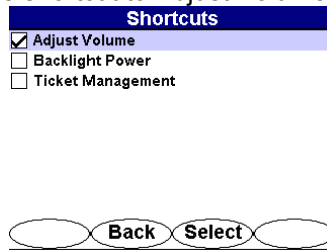

Figure 2-30 Adjust Volume Selection in Shortcuts Menu

Selecting Backlight Power places the shortcut to Backlight Power (BL).

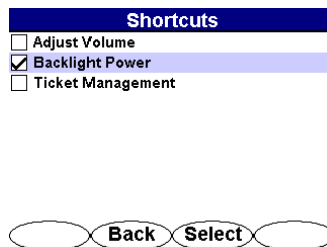

Figure 2-31 Backlight Power Selection in Shortcuts Menu

Selecting Ticket management places the shortcut to Ticket Management (TKT). Ticket Management takes you to the Data Logging Menu where you select Tickets.

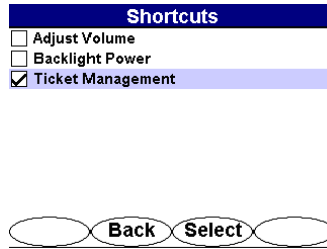

Figure 2-32 Ticket Management Selection in Shortcuts Menu

2.6 Data Logging Menu - Optional

The Data Logging feature provides data ticket management services.

Three selections are available in this menu:

- Tickets
- Data Log
- Record Mode

To access the data logging menu, use the 4-way navigation button to highlight the file folder icon. The chosen menu is also labeled Data Logging at the top of the menu screen. Press the <Select> soft key to open the desired menu screen. Press the <Back> soft key to return to the operational interface.

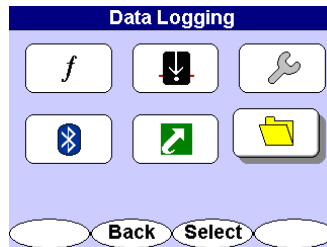

Figure 2-33 Data Logging Selection in Main Menu

2.6.1 Tickets

Two options are available on the tickets menu – creating tickets or viewing tickets.

Use the 4-way navigation button to move up and down the data logging list. Use the 4-way navigation button to move right and highlight the desired option. Press the <Select> soft key to open the menu. Press the <Back> soft key to return to the previous interface.

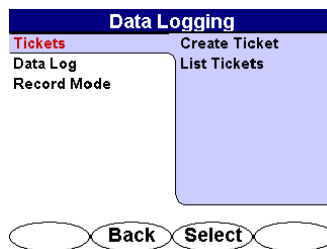

Figure 2-34 Tickets Selection in Data Logging Menu

2.6.1.1 Create Ticket

Create Ticket generates a new ticket on the receiver. A notification that a new ticket is being created appears on the screen for a few moments, then the screen returns to the Data Logging Tickets window.

Press the <Select> soft key to create a new ticket on the receiver.

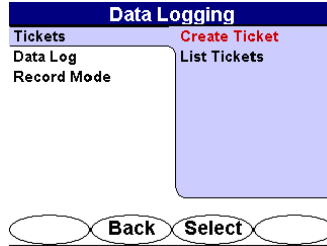

Figure 2-35 Create Ticket Selection in Data Logging Menu

2.6.1.2 List Tickets

All the tickets in memory will be listed along with the menu option - Information / Activate / Close / Enter Response.

To view a list of all tickets created, use the 4-way navigation button to move up and down the ticket list. Use the 4-way navigation button to move right and highlight the desired information. Press the <Select> soft key to open the ticket. Press the <Back> soft key to return to the previous interface.

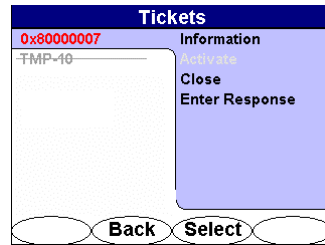

Figure 2-36 List Ticket Selection in Tickets Menu

2.6.1.3 Information

The Ticket Information header indicates the open or closed status. Selecting <Active> opens the ticket to logging additional data. Press the <Back> soft key to return to the previous interface.

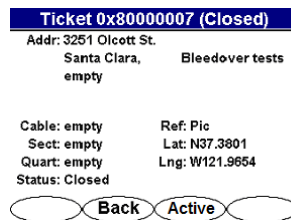

Figure 2-37 Ticket Information in Tickets Menu

2.6.1.4 Activate

Selecting **Activate** opens a ticket to logging data. Press the <Back> soft key to return to the previous interface.

2.6.1.5 Close

Selecting **Close** deactivates a ticket and no data will be logged under that ticket. The ticket name will be stricken through denoting its closure. See Figure 2-35.

2.6.1.6 Enter Response

Selecting **Enter Response** opens the response code list. The list is created by the user and downloaded from the MyLocator web service. A sample response code list is displayed.

Press the <Select> soft key to enter the correct response code or <Cancel> to return to the previous menu screen.

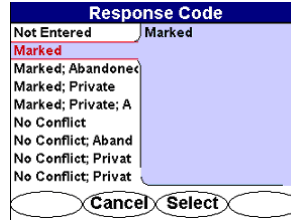

Figure 2-38 Sample Response Code Menu

2.6.2 Data Log

Log Memory displays the total Log Memory, Memory Used, and Number of Log Entries. Use the 4-way navigation button to highlight **Log Memory** and press the <Select> soft key to display the log data statistics.

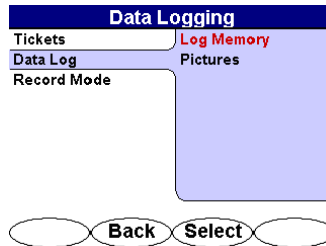

Figure 2-39 Log Memory Selection in Data Log Menu

2.6.2.1 Data Log Memory

The Data Log Memory screen lists the status of the *i5000* receiver memory. Press the <Back> soft key to return to the previous interface.

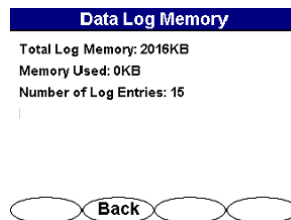
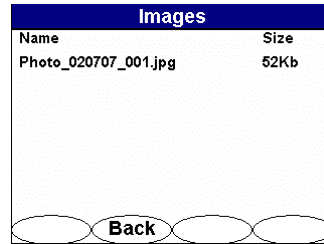

Figure 2-40 Data Log Memory in Data Logging Menu

2.6.2.2 Data Log Pictures

Selecting **Pictures** displays the name and size of all Locate Images in memory. Images are recorded in chronological order. No viewing capability is currently available on the receiver LCD. Images can be uploaded, however, to the MyLocator web service and viewed. Press the <Back> soft key to return to the previous interface.

To log a picture into the receiver memory, a Bluetooth-ready camera must be ON and ready for transmission. The *i5000* receiver must also be set on discoverable prior to transferring the image. The captured image can then be transmitted through the camera's send function. The receiver's blue LED will emit confirming that the Bluetooth connection is active.



Images	
Name	Size
Photo_020707_001.jpg	52Kb

Back

Figure 2-41 Pictures in Data Logging Menu

2.6.3 Record Mode

Record Mode allows the user to select the data logging format. Two choices are available for selection - **on Depth** or **on Depth + Timer**. Check with your supervisor what record mode should be used.

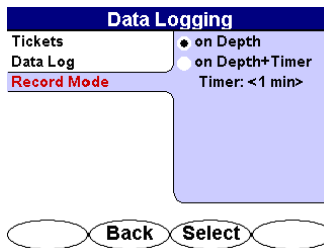

Data Logging	
Tickets	<input checked="" type="radio"/> on Depth
Data Log	<input type="radio"/> on Depth+Timer
Record Mode	Timer: <1 min>

Back Select

Figure 2-42 Record Mode in Data Logging Menu

1 Service and Maintenance

1.1 Maintenance

The only routine maintenance required for the equipment and accessories is to test and recharge or replace, if necessary, the batteries. A continuous battery test is a standard feature, making it easy to check the condition of the batteries at any time.

The i5000 receiver is designed for rugged outdoor use, but rough handling should be avoided. Keep the equipment dry, clean, and free of grit. Store the i5000 (in a dry carrying case) in a cool, dry place. Do not expose to excessive temperatures.

We recommend checking the receiver battery status before each use, preferably before leaving for the job site.

1.2 Service Center Information

If the equipment does not function properly, replace the batteries as described above. If the equipment still malfunctions, contact one of the Metrotech Customer Service departments:

Vivax-Metrotech Corporation

3251 Olcott Street,
Santa Clara, CA 95054, USA
Website : www.vivax-metrotech.com
Sales & Sales Support:
T/Free : +1-800-446-3392
Tel : +1-408-734-1400
Fax : +1-408-734-1415
Email : sales@vxmt.com

Application Support:

T/Free : +1-800-624-6210
Tel : +1-408-454-7159
Fax : +1-408-743-5597
Email : applications@vxmt.com

Service & Repairs:

T/Free : +1-800-638-7682
Tel : +1-408-962-9990
Fax : +1-408-734-1799
Email : service@vxmt.com

All Other Department:

T/Free : +1-877-330-1647
Tel : +1-408-734-3880
Fax : +1-408-962-9993

Canada

Vivax Canada Inc.
400 Esna Park Drive,
Unit 17, Markham,
Ontario, L3R 3K2, Canada
Tel : +1-289-846-3010
Website : www.vivax-metrotech.com
Email : CanadianSales@vxmt.com

Europe

SebaKMT
Seba Dynatronic
Mess-und Ortungstechnik GmbH
Dr.-Herbert-Iann-Str. 6,
96148 Baunach, Germany.
Tel : +49-9544-680
Fax : +49-9544-2273
Website : www.sebakmt.com
Email : service@sebakmt.com

Australasia

SebaKMT AUS
Unit 1, 176 South Creek Road,
Cromer NSW 2009, Australia
Tel : +61-2-9972-9244
Fax : +61-2-9972-9433
Website : www.sebakmtaus.com
Email : sales@sebakmtaus.com
service@sebakmtaus.com

China

Leidi Utility Supply (Shanghai) Ltd.
Rm405 3rd Building No. 641, Tianshan Rd,
Shanghai, China 200336
Tel : +86-21-5187-3880
Fax : +86-21-5168-5880
Website : www.leidi.com
Email : info@leidi.cn

Or call the Metrotech headquarters for the nearest authorized Metrotech repair station. Metrotech also manufactures and distributes these instruments: Pipe and Cable Locators, Ferromagnetic Locators, Fiber Optic Cable Locating System, Sheath Fault Locators, Electronics Marker Locators, Acoustic Water Leak Detectors, Water Leak Sound Correlators and Data Loggers. For more details, see our website www.metrotech.com.

2 Warranty

THERE ARE NO WARRANTIES, EXPRESSED OR IMPLIED, INCLUDING ANY WARRANTY OF MERCHANTABILITY, BEYOND THOSE STATED HEREIN.

Metrotech warrants its equipment to be free from defects in workmanship and material under normal and proper use and service for one year from date of purchase by original user. Metrotech assumes no obligation to repair or replace equipment which has been altered or repaired by other than a Metrotech-approved procedure, been subject to misuse, misapplication, improper maintenance, negligence, or accident; has had its serial number or any part thereof altered, defaced or removed; or been used with parts other than those approved by Metrotech. Warranty does not include batteries. Expendable items such as fuses and lamps are excluded. Any detection product proved defective under this warranty will be repaired or replaced free of charge at the Metrotech Corporation factory or approved Metrotech repair station. The equipment should be returned to our factory by prepaid transportation after requesting and receiving return authorization from our Customer Service Department. Metrotech's obligations are limited to repair or replacement of broken or defective parts which have not been abused, misused, altered, or accidentally damaged, or at the option of Metrotech, to refund of the purchase price. Metrotech assumes no liability for removal or installation costs, consequential damages, or contingent expenses of any other nature.

3 Copyright Notice

The information contained in this document is for informational purposes only and is subject to change without notice. Metrotech Corporation makes no warranty of any kind with regard to the information contained in this manual, including but not limited to the implied warranties of merchantability and fitness for a particular purpose. Metrotech shall not be liable for errors contained herein, nor for incidental or consequential damages from the furnishing of this information.

This manual contains proprietary information that is protected by copyright. All rights are reserved. No part of this manual may be photocopied, reproduced, magnetically or electronically stored, transmitted, or translated into another language without the prior written consent of Metrotech Corporation.

Bluetooth® is a registered trademark of Bluetooth SIG Inc.

© Metrotech Corporation 2008 - All Rights Reserved