



10W Transmitter

SERVICE CENTER, SALES AND TECHNICAL SUPPORT INFORMATION

Vivax-Metrotech Corporation
3251 Olcott Street,
Santa Clara, CA 95054, USA
Website : www.vivax-metrotech.com

Sales & Sales Support:
T/Free : +1-800-446-3392
Tel : +1-408-734-1400
Fax : +1-408-734-1415
Email : sales@vxmt.com

Application Support:
T/Free : +1-800-624-6210
Tel : +1-408-454-7159
Fax : +1-408-743-5597
Email : applications@vxmt.com

Service & Repairs:
T/Free : +1-800-638-7682
Tel : +1-408-962-9990
Fax : +1-408-734-1799
Email : service@vxmt.com

All Other Department:
T/Free : +1-877-330-1647
Tel : +1-408-734-3880
Fax : +1-408-962-9993

Canada
Vivax Canada Inc.
400 Esna Park Drive,
Unit 17, Markham,
Ontario, L3R 3K2, Canada
Tel : +1-289-846-3010
Website : www.vivax-metrotech.com
Email : CanadianSales@vxmt.com

Europe
SebaKMT
Seba Dynatronic
Mess-und Ortungstechnik GmbH
Dr.-Herbert-lann-Str. 6,
96148 Baunach, Germany.
Tel : +49-9544-680
Fax : +49-9544-2273
Website : www.sebakmt.com
Email : service@sebakmt.com

Australasia
SebaKMT AUS
Unit 1, 176 South Creek Road,
Cromer NSW 2009, Australia
Tel : +61-2-9972-9244
Fax : +61-2-9972-9433
Website : www.sebakmtaus.com
Email : sales@sebakmtaus.com
service@sebakmtaus.com

China
Leidi Utility Supply (Shanghai) Ltd.
Rm405 3rd Building No. 641, Tianshan Rd,
Shanghai, China 200336
Tel : +86-21-5187-3880
Fax : +86-21-5168-5880
Website : www.leidi.com
Email : info@leidi.cn



VIVAX
METROTECH

1 INTRODUCTION



The Metrotech Model *i5000* is a series of state-of-the-art utility line locators precisely designed with many powerful features to provide you with optimum information about your locate situation.

Included are a system overview, product specifications, quick start procedure for experienced users, and maintenance instructions.

2 GENERAL INFORMATION AND SAFETY

Symbols used in this manual

Important instructions concerning the protection of staff and equipment as well as technical safety within this document are labelled with one of the following symbols:

Symbol	Description
 WARNING	Indicates a potentially hazardous situation, which, if not avoided, could result in death or serious injury.
 CAUTION	Indicates a potentially hazardous situation, which, if not avoided, may result in minor or moderate injury or material damage.
	Notes have important information and useful tips on the operation of your equipment. Non-observance may result in incorrect measurement results.

Operating personnel

Metrotech utility line locators are intended for use by utility and contractor professionals. Safety hazards for underground utility access areas include electrical shock, explosive gases, and toxic fumes as well as potential influence on communications and control systems such as traffic control and railroad crossings.

Repair and maintenance

Repairs and service must only be done by Metrotech Corporation or authorized service departments of Metrotech Corporation.

3 SAFETY PRECAUTIONS

This manual contains basic advice for the installation and operation of Metrotech Utility Line Locators and accessories. The manufacturer is not liable for damage to material or humans due to non-observance of the instructions and safety advice provided in this manual. Therefore, this manual should be provided and reviewed by all personnel associated with the line locating equipment.

Observed Safety Practices

Familiarize yourself with all required safety practices of the local utility company, or other owner of the plant before entering an access area, or connecting a Metrotech transmitter.

Ensure that the line is de-energized and out of service, before connecting the transmitter directly to any conductor. NEVER make a direct connection to a live power cable.

Follow the appropriate safety procedures to avoid the risk of injury if using a clamp on energized electrical or control lines.

Pay special attention when using a locator in high traffic areas.

Intended application

Safe operation is only realized when using the equipment for its intended purpose. Using the equipment for other purposes may lead to human danger and equipment damage.

The limits described under the technical data section may not be exceeded.

Malfunctioning Behavior

The equipment may only be used when working properly. When irregularities or malfunctions appear that cannot be solved consulting this manual, the equipment must immediately be put out of operation and marked as not functional. Metrotech Coporation must be contacted for technical support and/or service. The instrument may only be operated when the malfunction is resolved.

FIVE SAFETY RULES

The five safety rules must always be followed when working with High Voltage (HV):

- De-energize
- Protect against re-energizing
- Confirm absence of voltage
- Ground and short-circuit
- Cover up or bar-off neighboring energized parts



Fire fighting in electrical installations:

Recommended extinguishing agent: carbon dioxide (CO₂)
Carbon dioxide is electrically non conductive and does not leave residue. It is safe to use in energized facilities as long as the minimum distances are observed.

It is essential to observe the safety instruction on the extinguishing agent.



Dangers when operating with HV:

Special safety attention is needed when operating HV facilities, especially non-stationary equipment. The regulations VDE 0104 about setting up and operation of electric test equipment, i.e. the corresponding EN 50191 as well as country-specific regulations and standards must be observed. Safety installations may not be by-passed nor deactivated.

Operation requires a minimum two people whereas the second person must be able to activate the emergency switch in case of danger.

To avoid hazardous electric charges of metallic parts in the vicinity, all metallic parts must be grounded.

To avoid drawing dangerous arcs, switching should only be done in a de-energized condition.

The equipment and all accessories must be connected according to applicable standards VDE, EN or DIN as well as country-specific regulations.

1 Quick Start Guide for the Experienced User

a	Battery Status
b	Audio Volume
c	Signal Select
d	Direct Connection
e	Frequency in Use
f	Power Output Level
g	Constant Power
h	Active Frequency Menu
i	Power Output in Use
j	Resistance Output Level

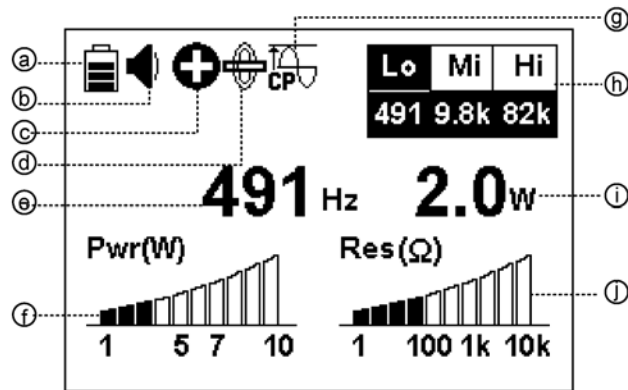



Figure 1-1 Direct Connection Mode Display

1) Check the battery status on the display.

- a)  Press the **Power ON** button to turn on the transmitter. An amber LED will illuminate. The *i5000* introduction screen is displayed for two seconds before displaying the operational display as above.
- b) Check battery level - If the battery status is low (1 bar), replace or recharge the battery. The battery charging connection is located on the transmitter's side panel.
 - i) Using a higher power output or SFL will deplete battery life at a faster rate.

2) Choose the best active connection method.



- a) Direct Connection (with conductive attachments)
 - i) Connecting directly to the target utility provides a higher field strength
 - ii) North America Base Frequencies (Hz): 491, 982, 8.44k, 9.82k, 35k, 82k, 83k
 - iii) International Base Frequencies (Hz): 491, 577, 640, 982, 8.192k, 8.44k, 9.82k, 35k, 82k, 83k
- b) Clamp (induction)
 - i) Connecting with Metrotech's MetroClamp or Signal Select clamp
 - ii) Base Frequencies (Hz): 9.82k, 82k
- c) Induction (with internal induction coil)
 - i) Base Frequencies (Hz): 9.82k, 82k

3) Connect the Transmitter to the Conductor (for direct connection).

- a) With the transmitter **OFF**, plug the conductive attachment located on the side panel.
- b) Stretch the black lead 90 degrees away from the conductor. Push the ground rod as deeply as possibly into the earth. Connect the black lead to the ground rod.
- c) Clamp the red lead to the target conductor, ensuring good metal-to-metal contact.
- d) Press the **Power ON** button.



4) Select Frequency.

- a) The *i5000* saves the selected frequencies from the last locate. See figure 1.1 (h).
- b)  Toggle up/down to change from Lo/Mi/Hi frequency menu.
- c)  Press the **frequency** button to change the active frequency displayed.
- d) To change the quantity of active frequencies available for locating,
 - i) Press <Menu>.
 - ii) Toggle up/down to select **Output Mode** from the **i5000 Main Menu**.
 - iii) Press <Select>.
 - iv) Toggle up/down to select **Direct Mode Configuration**.
 - v) Press <Select>.
 - vi) Toggle left/right to choose 1x or 3x.
 - vii) Press <Select>.







5) Select Power Setting.

- a) The *i5000* has two output choices (see figure 1.1 (g)):
 - i) Constant Current
 - ii) Constant Power (the factory default to maximize field strength and battery life)
- b) To change the output setting, use the three-button navigational keypad.
 - i) Press <Menu>.
 - ii) Toggle up/down to select **Output Mode** from the **i5000 Main Menu**.
 - iii) Press <Select>.
 - iv) Toggle up/down to select the desired output mode.
 - v) Press <Select>.

6) The transmitter is ready for use.

1.1 Controls





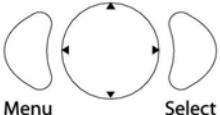







The *i5000* possesses nine (9) functional buttons to operate the transmitter.

Control	Description
	Power ON – Pressing the button turns the transmitter ON or OFF. An amber LED illuminates when the transmitter is ON.
	Circuit Condition – Only available when direct connected. Pressing the button allows the operator to toggle through and view the actual condition of the circuit in volts, milliamps, watts, and ohms.
	Output Level – Pressing the button allows the operator to change the output level. Repeated pressing or using the left/right navigational button increases or decreases the output level.
	Signal Select – Pressing the button turns Signal Select, a feature facilitating positive line identification, ON or OFF.
	Frequency Select – Pressing the button allows the operator to toggle through the active frequencies.
	Sheath Fault Locate (SFL) – Pressing the button turns the SFL feature ON or OFF. A red LED illuminates when the feature is ON.

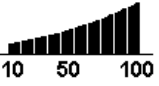
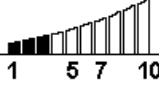
Control	Description
	Three-Button Navigational Keypad – Pressing the buttons enables the operator to navigate through and select the available operational menu screens and active frequency select menu.

1.2 Transmitter Display Indicator Icons

The *i5000* uses intuitive symbols to represent the various transmitter features.

Icon	Description
	Direct Connection Mode - If displayed, direct connection operation is active.
	Clamp – If displayed, a clamp is connected to the transmitter.
	Inductive Connection Mode – If displayed, inductive connection operation is active.
	Battery Status – Displays the available battery charge capacity from low to full.
	Sheath Fault Locate Protection – If displayed, sheath fault locate feature is active.
	Audio Volume – Displays the configured audio volume level from off to high.
	% Power Output – Displays the configured power input percentage in SFL or induction mode (clamp and internal antenna).
	Power Output Level – Displays the configured power input in Watts (W) in direct connection mode.
	Resistance (Ω) Output Level – Displays the loop resistance graph
	Constant Power Output – If displayed, constant power feature is active.
	Constant Current Output - If displayed, constant current feature is active.
	Live Voltage Warning - If displayed, the Power Protection feature is ON.
	Signal Select – If displayed, signal select modulation is active.
	Active Frequency Menu – Displays the active frequencies.

1 i5000 Transmitter System Overview

The Transmitter has two main operator interfaces – the Main Panel and the Side Panel.

1.1 Main Panel Display

The i5000 Transmitter includes an LCD menu display and a three-button navigational keypad for operation and setup modes. Six individual buttons enable the operator to easily change frequency settings or output level; activate power (ON/OFF) or SFL; and view the circuit condition. See figure below.

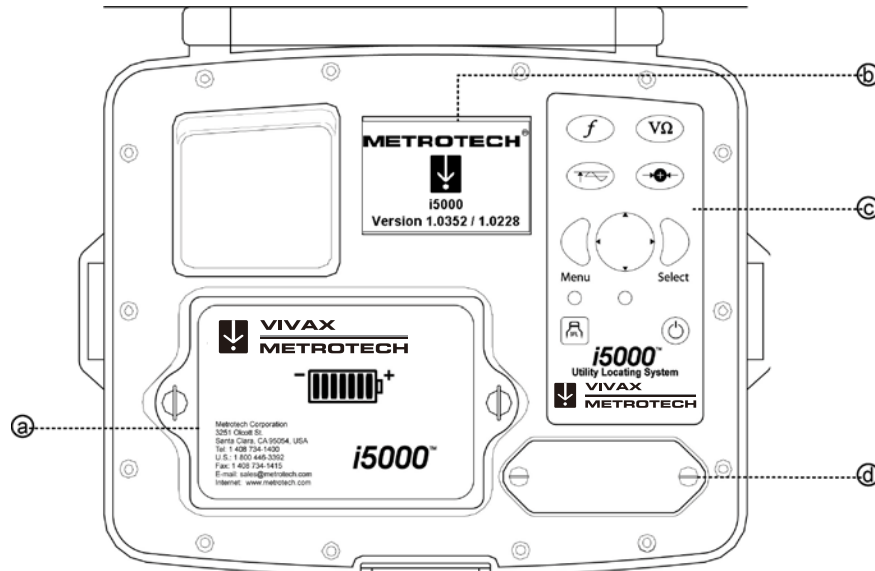





Figure 1-1 Main Panel Display View

Main Panel Legend	
a.	Rechargeable Battery
b.	Operational Interface
c.	Controls
d.	RS232 Serial Port and Fuse

1.2 Controls

The i5000 possesses nine (9) functional buttons to operate the transmitter.

Control	Description
	Power ON – Pressing the button turns the transmitter ON or OFF. An amber LED illuminates when the transmitter is ON.
	Circuit Condition – Only available when direct connected. Pressing the button allows the operator to toggle through and view the actual condition of the circuit in volts, milliamps, watts, and ohms.
	Output Level – Pressing the button allows the operator to change the output level. Repeated pressing or using the left/right navigational button increases or decreases the output level.
	Signal Select – Pressing the button turns Signal Select, a feature for positive line identification, ON or OFF.

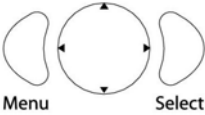
Control	Description
	Frequency Select – Pressing the button allows the operator to toggle through the active frequencies.
	Sheath Fault Locate (SFL) – Pressing the button turns the SFL feature ON or OFF. A red LED illuminates when the feature is ON.  Never connect the transmitter leads to live voltage! Refer to the manual safety section for further guidelines.
	Three-Button Navigational Keypad – Pressing the buttons enables the operator to select and navigate through the operational menu screens and active frequency menu.

1.3 Side Panel Display

The *i5000* Transmitter has the following output jacks for battery charging, inductive clamps, and safety ground. See figure below.

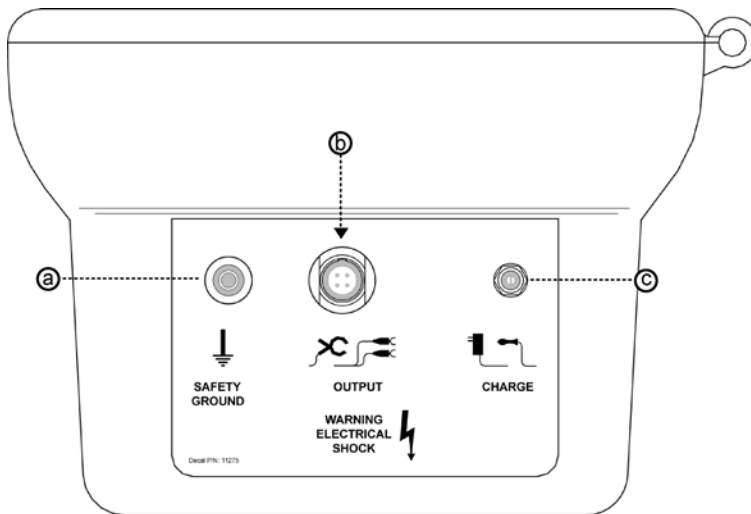













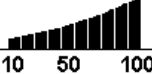

Side Panel Connections	
a.	Safety Ground
b.	Direct Connect or Clamp
c.	Charge or external 12VDC

Figure 1-2 Side Panel Display View

1.4 Transmitter Display Indicator Icons

The *i5000* uses intuitive symbols to represent the various transmitter features.

Icon	Description
	Direct Connection Mode - If displayed, direct connection operation is active.
	Inductive Connection Mode – If displayed, inductive connection operation is active.
	Clamp – If displayed, a clamp is connected to the transmitter.
	Battery Status – Displays the available battery charge capacity from low to full.
	Sheath Fault Locate– If displayed, sheath fault locate feature is active.
	Audio Volume – Displays the configured audio volume level from off to high.
	% Power Output – Displays the configured power input percentage in SFL or induction mode (clamp and internal antenna).
	Power Output – Displays the configured power input in Watts (W) in direct connection mode.
	Resistance (Ω) Output Level – Displays the loop resistance graph
	Constant Power Output – If displayed, constant power feature is active.
	Constant Current Output - If displayed, constant current feature is active.
	Live Voltage Warning - If displayed, the Power Protection feature is ON.
	Signal Select – If displayed, signal select modulation is active.
	Active Frequency Menu – Displays the active frequencies

1.5 Operational Interface

The *i5000* transmitter operational screen is a 1/8 VGA monochrome graphical display. The information displayed is dependent upon the active operation mode - direct (conductive) connection, inductive mode with clamp connection, inductive antenna connection, and SFL.

1.5.1 Direct (Conductive) Connection Mode

A sample direct connection operational screen is below.

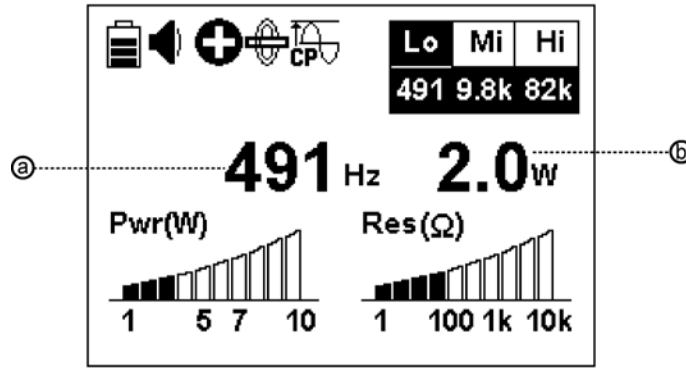

Figure 1-3 Direct Connection Operational Screen Display

Operational Screen Legend	
a.	Frequency in Use
b.	Output Power in Use/Circuit Condition Display

1.5.2 Inductive Connection Mode with Clamps

A sample inductive clamp connection operational screen is below.

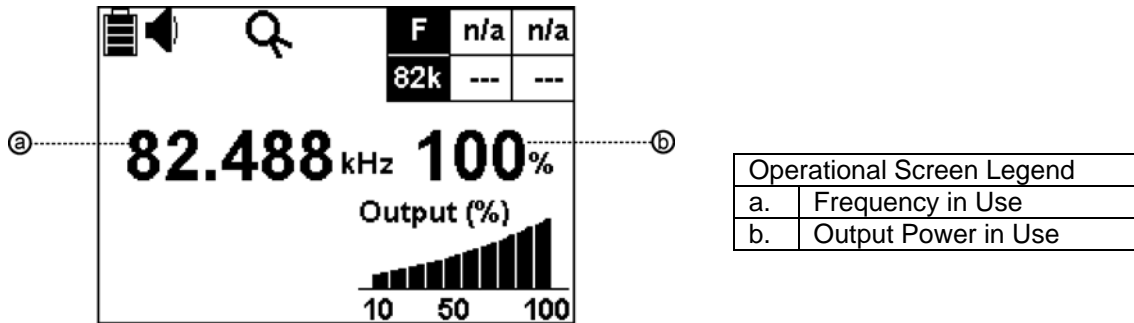

Figure 1-4 Induction Mode with Clamp Operational Screen Display

1.5.3 Inductive Antenna Connection Mode

A sample inductive antenna connection operational screen is below.

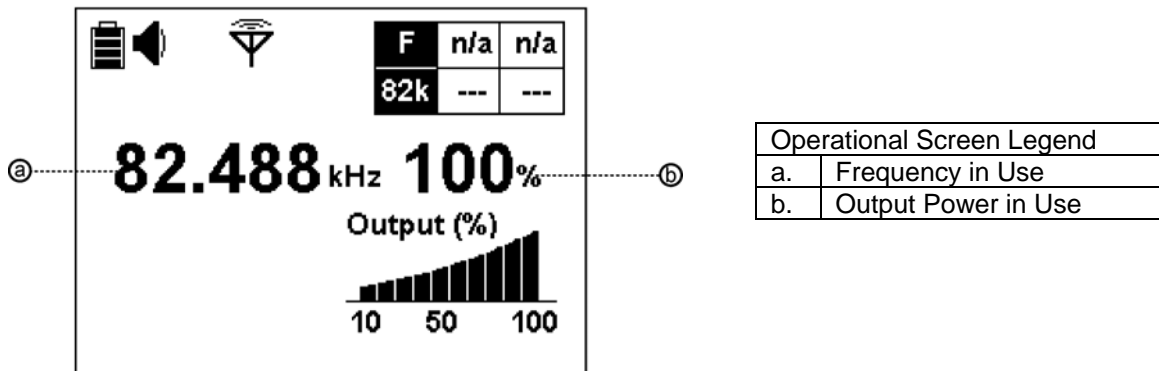

Figure 1-5 Inductive Antenna Connection Operational Screen Display

1.5.4 Sheath Fault Locating (SFL) Mode

A sample SFL operational screen is below.

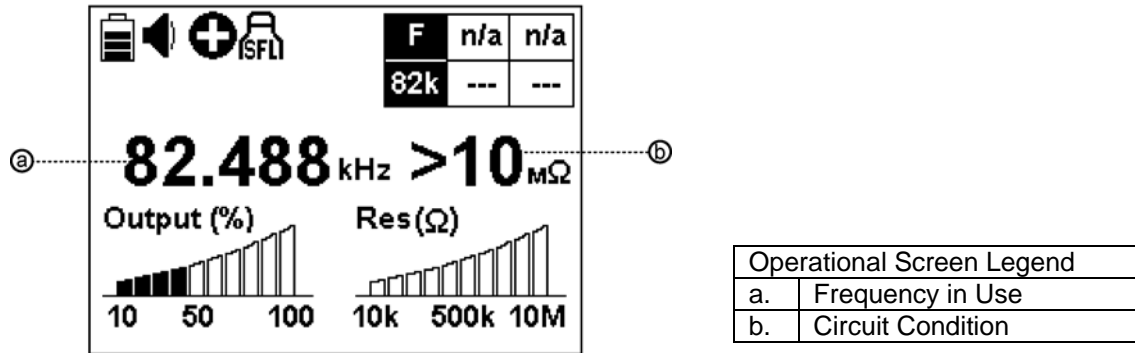

Figure 1-6 Sheath Fault Locating (SFL) Mode Operational Screen Display

1 *i5000* Transmitter Technical Specifications

Output Frequencies (Hz)	491, 982, 8.44k, 9.82k, 35k, 82k, 83k (North America) 491, 577, 640, 982, 8.192k, 8.44k, 9.82k, 35k, 82k, 83k Extended and special frequency sets available
Output Power	Variable to 10W
Simultaneous Output	Up to three active frequencies
Controls	Frequency select, measurement units (mA, Volts, Ohms, Watts), output power, Signal Select™, menu, 4-way navigation, select, SFL, On/Off
Display Indicators	Battery status, audio volume, output mode, frequency setting, frequency output, % output in SFL or induction mode, output graph, loop resistance graph
Display	1/8 VGA monochrome
Battery Type	NiMH rechargeable or six (6) D alkaline
Battery Life	6 – 12 hours continuous use, depending on power level and line conditions
Operation Temperature	-4°F to +122° F (-20°C to +50° C)
Dimensions	11" W x 6 ¾" H x 9" L (27.9 cm x 17.1 cm x 22.9 cm)
Weight	8.24 lbs. (3.7 kg)
Regulatory Compliance	FCC, CE
Environmental	IP54

2 Options

Sheath fault locating transmitter and A frame
MyLocator™ data warehousing and analysis web service

3 Accessories

3.1 Standard

Nylon carrying strap
Smart conductive attachments
Ground rod
Nylon carrying case for conductive attachments and ground rod
Operations manual

3.2 Optional

Inductive MetroClamp – 2" (50mm) and 4" (100mm)
Signal Select™ Clamp 4" (100mm)
Transmitting sondes
Spare rechargeable battery packs and chargers
Serial interface cables
Soft carrying cases

1 *i5000* Transmitter Features

The Metrotech Model *i5000* Transmitter enables the operator to easily locate utilities by applying an identifiable signal.

The following information describes the features currently available on the *i5000* Transmitter.

1.1 Output Power

The *i5000* Transmitter output is configurable up to 10W. FCC rules, however, determine the actual maximum output for a Part 15 device.

1.1.1 Output Power in Direct (Conductive) Connection Mode

Direct Connection is the preferred method of applying a signal to a conductor, and the output power can be transmitted with either power or current constant. This setting applies to all selected active frequencies (up to three simultaneously). The output selection can be configured in increments of 1X, 2X, 5X, and 10X up to a maximum of 10W or 1A respectively.

Constant current controls the current at a specific level for the circuit, composed of the target conductor and a ground return. Using constant current mode allows a direct comparison of the current measurement at the *i5000* Receiver (calculated as part of the depth measurement) with the applied current at the *i5000* Transmitter.

Constant power controls the total power transmitted to a maximum of ten (10) W. Using the constant power setting maximizes the transmitted output for the selected active frequency(ies).



Depending on field conditions, like the resistance of the target utility and ground return, it may not be possible to achieve the selected power or constant current. In this case, the *i5000* Transmitter display indicates the exact current level for each frequency on the display.

1.1.2 Output Power in Induction Mode

A constant power signal is the applied output mode for all applicable frequencies (9.8kHz or 82kHz). The output selection can be configured for a specific frequency in increments of 10%, 25%, 50%, 75%, or 100% of maximum power.

1.1.2.1 Induction Mode with Clamps



Inductive coupling with a clamp is the next best method of getting a signal onto your target conductor, if a direct (conductive) connection is not possible.

	If you are using a clamp around a cable, both ends of the cable must be grounded. This ensures a ground return path for optimum current flow (signal strength). Power lines and telephone sheaths are generally grounded.
	When tracing lines that have insulators (i.e. gas meters), the insulators should be temporarily bypassed.

1.1.2.2 Induction Mode with the Internal Antenna

Induction mode with the internal antennae is the least effective method of applying a signal to isolate one conductor. The signal is broadcast in all directions and can couple to every nearby conductor through electromagnetic induction.

When the Transmitter is “ON”, it will broadcast the signal from the internal antenna. No ground connection is needed when a signal is induced onto the target conductor.

	Operating the Transmitter in the Inductive Mode while it is resting on or near a metal surface or large metal object is not recommended. Incorrect test readings and damage to the Transmitter may result
	In this mode, the conductive attachment and clamp should be removed.

1.2 Simultaneous Output Frequencies

The *i5000* Transmitter frequency feature enables an operator to configure up to three active frequencies. Simultaneous transmission of multiple frequencies in direct (conductive) connection mode allows the operator to select the best frequency for the locate job without returning to the transmitter.

A single active frequency can be selected for induction mode.

The output frequencies available for transmission are as follows:

Region	Frequency (Hz):
North America	Direct: 491, 982, 8.44k, 9.82k, 35.4k, 82k, 83k
International	Direct: 491, 577, 640, 982, 8.44k, 9.82k, 35.4k, 82k, 83k

An option for extended and special frequency sets is available through Metrotech.

1.3 Signal Select



Signal Select is a special modulation placed on the tracked line, when the locate is performed in direct connection mode, to support positive line identification. This feature is available on select frequencies – 491Hz, 982Hz, 8.44kHz, 9.82kHz, 35.352kHz, 82.88kHz, 83.078kHz, and activated from the frequency menu.

The Signal Select icon is displayed on the operational menu screen if in use.

1.4 Sheath Fault Locate (SFL)







The Sheath Fault Locate feature is used to locate insulation faults on direct buried electric power, telecommunication, or CATV cables. When activated, SFL produces the voltage and frequency for locating sheath faults. Because of the high rate of battery consumption required by this feature, using a fully charged battery is recommended.

The A-Frame receiver is included in the SFL option. Reviewing the SFL operations manual is recommended prior to use.

	Always insert and connect the earth ground rod before turning on the transmitter. Never pull out the earth ground rod as long as the transmitter is switched on!
	Never connect the transmitter leads to live voltage!

1.5 Power Protection

The Power Protection feature shields the transmitter from potential damage caused by connecting to a live power voltage cable. If live voltage is detected on the line, the power protection icon is displayed on the operational menu screen and protection is provided for an unlimited time up to a maximum voltage of 250VAC.

	Power Protection is designed to protect the TRANSMITTER ONLY from catastrophic failure. The operator should follow all applicable safety rules to prevent personal danger.
	Always de-energize and ground all cables before connecting. The operator should follow all applicable safety rules to prevent personal danger.
	Never connect the transmitter leads to live voltage!
	Always insert and connect the earth grounding rod before turning on the transmitter. Never pull out earth grounding rod as long as the transmitter is switched on!
	Power Protection does protect the transmitter if the connected target line becomes energized after the initial connection of the leads and the transmitter is switched to the ON state.
	Power Protection cannot protect the <i>i5000</i> Transmitter if the connected target line becomes energized after the initial connection of the leads and the transmitter is switched to the ON state. Always connect the transmitter leads to the target line first, when the transmitter is OFF. Then turn on the <i>i5000</i> Transmitter. If there is AC power present on the target line, the transmitter will enter Power Protection mode automatically.
	At frequencies below 1kHz, the Power Protection circuit will limit the current output. In these cases, selecting a higher frequency to allow a greater current is recommended.

1.6 Impedance Matching

Automatic impedance matching optimizes the output efficiency for line impedances from 5Ω to 5kΩ.

1.7 Smart Accessory Detection

The *i5000* automatically detects the output accessory connected to the transmitter’s side panel such as direct connection leads, inductive clamps, high voltage SFL leads, or to automatically acquire calibration information from the accessory.

1.8 Preset State

The *i5000* restores the configured settings – frequency, mode, and system, from the last state at power on. From the systems settings menu, the transmitter can default to the original factory settings or restore the My Preset State configuration.

The factory default settings are:

Feature	Factory Setting
Volume	Low
Frequency	User selected
Signal Select	On
SFL	OFF
Output Mode (direct)	Constant Power
Power Protection	Automatic On
Backlight	Automatic On
Bluetooth Wireless	On, Discoverable

1.9 Bluetooth Wireless Interface



The *i5000* Bluetooth wireless feature allows the operator to transmit data from the transmitter to another Bluetooth-enabled device such as an *i5000* Receiver or computer.

The transmitter's software can be updated and maintained with access to Metrotech's web service, MyLocator, and the Bluetooth wireless interface.

1.10 Battery Operation

The *i5000* Transmitter can use various types of batteries. Depending upon use, an operator can expect typical battery performance in continuous operation as follows.

NiMH	6-12 hours
Li-ion	8-12 hours
Alkaline	Up to 6 hours

	Excess heat can damage batteries, causing a rupture or ignition. Do not place batteries near fire, heat, or in direct sunshine.
	Batteries contain hazardous material that may be harmful to the environment. Dispose used batteries sensibly. Follow local recycling guidelines for disposal of similar material.

1 *i5000* Transmitter Menu System

The *i5000* Transmitter consists of software menus to set up key operational features. The following information describes the procedure to configure all available menus.

The *i5000* introduction screen is displayed upon powering the transmitter. The instrument model number and installed software versions are displayed.

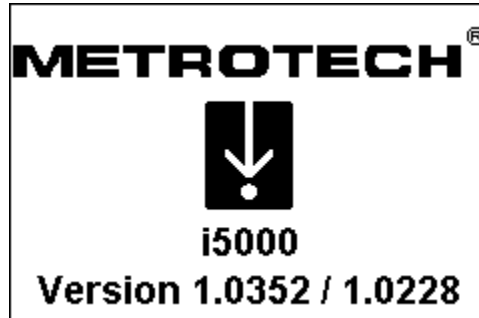

Figure 1-1 *i5000* Transmitter Introduction Screen

2 *i5000* Main Menu

The Transmitter includes five (5) selectable menus for operation.

The desired menu is selected using the three-button navigational keypad. Press <Menu>. Press the up/down arrows to select the desired menu option. Press <Select> to open the desired menu screen. Press <Menu> to return to the operational display screen.

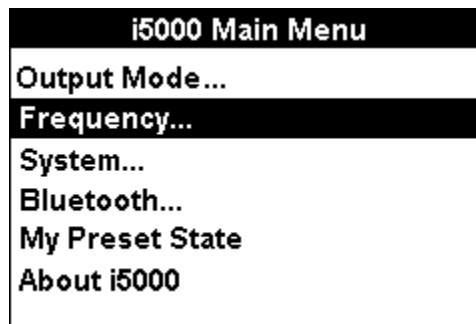

Figure 2-1 Main Menu Screen

2.1.1 Output Mode Menu

The *i5000* Transmitter output mode menu allows the operator to configure the desired output settings – constant current, constant power, or direct mode.

The desired output mode is configured using the three-button navigational keypad. Press the up/down arrows to select the desired output. Press <Select> to activate the desired output. The transmitter automatically returns to the operational display screen and the selected display indicator icon is visible.

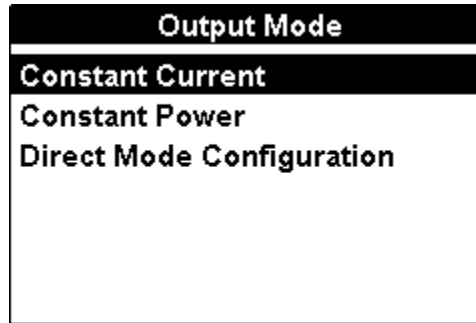

Figure 2-2 Output Mode Menu Screen

2.1.2 Output Mode Menu – Direct (Conductive) Mode Configuration

The *i5000* Transmitter allows the operator to configure up to three active frequencies simultaneously in direct (conductive) connection mode.

The desired direct mode is configured using the three-button navigational keypad. Press the left/right arrows to select the desired quantity of active frequencies available for use simultaneously. Press <Select> to activate the desired configuration. The transmitter displays the active configuration and returns to the operational display screen.

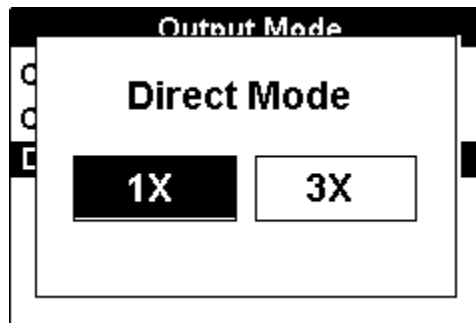

Figure 2-3 Direct Mode Configuration Screen in Output Mode Menu

2.2 Frequency Menu

The *i5000* Transmitter frequency menu allows the operator to configure the desired active frequency(ies). Different menu screens appear depending upon the connection mode – direct (conductive), inductive coupling with clamps, or inductive antenna. The operator can then select the desired available frequencies.

Sheath fault locating (SFL) frequency selection is discussed separately. Please refer to Section 3 for configuration.

The desired menu is selected using the three-button navigational keypad. Press <Menu>. Press the up/down arrows to select the desired menu option. Press <Select> to open the desired menu screen. Press <Menu> to return to the operational display screen.

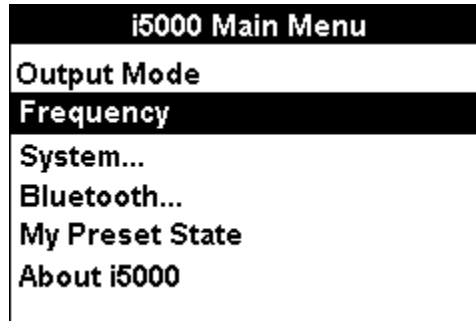

Figure 2-4 Frequency Selection in Main Menu

2.2.1 Frequency Menu - Direct (Conductive) Connection Mode

Direct (conductive) connection mode allows the operator to configure up to three active frequencies. The operator is limited to selecting one frequency in each frequency menu – low, mid, and high.

The desired frequency settings menu is configured using the three-button navigational keypad. Press the up/down arrows to select the desired option. Press <Select> to open the desired frequency settings menu. Press <Menu> to return to the previous screen.

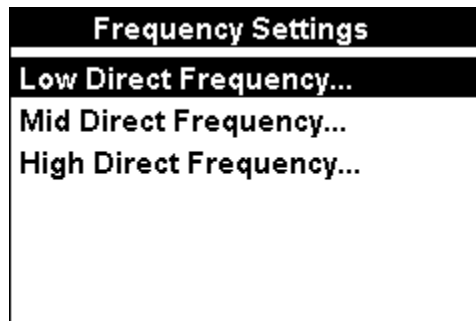



Figure 2-5 Frequency Settings Menu Screen in Direct Connection Mode

The desired frequency is configured using the three-button navigational keypad. Press the up/down arrows to select the desired frequency. Press <Select> to activate the desired frequency.

Press the Signal Select button, , to activate or deactivate the Signal Select feature if available. The activated Signal Select frequency is marked with an **X**. An operator can activate the Signal Select feature for all available frequencies even if the frequency is not currently selected for use.

Repeatedly pressing the output level control button, , allows the operator to configure the output current or power of the selected frequency. The output can be increased in 1X, 2X, 5X, or 10X increments up to 1A or 10W, respectively.

Press <Menu> or <Select> to return to the frequency settings menu screen. Press <Menu> to return to the operational display screen.

Low Frequency		+ + +	Current
<input type="radio"/>	None		
<input checked="" type="radio"/>	491Hz	<input checked="" type="checkbox"/>	50mA
<input type="radio"/>	512Hz		1000mA
<input type="radio"/>	982Hz	<input checked="" type="checkbox"/>	1000mA

Figure 2-6 Low Frequency Menu Screen in Direct Connection Mode

Mid Frequency		+ + +	Power
<input checked="" type="radio"/>	None		
<input type="radio"/>	8.440kHz	<input checked="" type="checkbox"/>	1W
<input type="radio"/>	9.820kHz	<input checked="" type="checkbox"/>	1W
<input type="radio"/>	35.352kHz	<input checked="" type="checkbox"/>	1W

Figure 2-7 Mid Frequency Menu Screen in Direct Connection Mode

High Frequency		+ + +	Power
<input checked="" type="radio"/>	None		
<input type="radio"/>	65.536kHz		500mW
<input checked="" type="radio"/>	82.488kHz	<input type="checkbox"/>	500mW
<input type="radio"/>	83.078kHz	<input checked="" type="checkbox"/>	500mW
<input type="radio"/>	166kHz		250mW

Figure 2-8 High Frequency Menu Screen in Direct Connection Mode

2.2.2 The Frequency Menu - Inductive Coupling with Clamps

Inductive coupling with Metrotech clamps enables the operator to induce a signal onto the target conductor. Inductive coupling with clamps allows the operator to configure one active frequency for operation – 9.82kHz or 82.488kHz. 83.078kHz and 166kHz frequencies are optional.

2.2.2.1 Frequency Menu – Inductive Coupling with the *i5000* MetroClamp

Inductive coupling with the *i5000* MetroClamp enables the operator to select one active frequency. Frequency selection is not configurable through the frequency menu screen.

Frequency selection is activated by pressing the frequency button, .

2.2.2.2 Frequency Menu – Inductive Coupling with the Signal Select™ Clamp

The desired clamp frequency is configured using the three-button navigational keypad. Press <Select> to activate the desired frequency. Press <Menu> to return to the frequency settings menu.

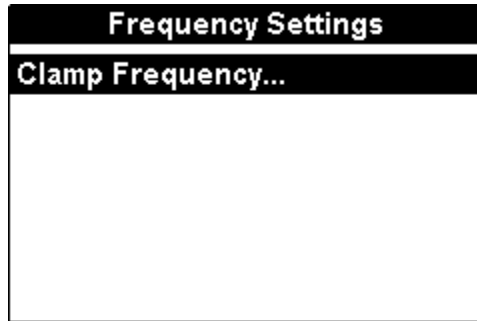



Figure 2-9 Clamp Frequency Menu screen in Inductive Coupling Mode

The desired frequency is configured using the three-button navigational keypad. Press the up/down arrows to select the desired frequency. Press <Select> to activate the desired frequency.

Repeatedly pressing the output level control button, , allows the operator to configure the output current or power of the selected frequency. The applied output can be increased incrementally by 10%, 25%, 50%, 75%, or 100% of maximum power.

Press <Menu> or <Select> to return to the frequency settings menu screen. Press <Menu> to return to the operational display screen.

Clamp Frequency	Output
<input checked="" type="radio"/> 9.820kHz	100%
<input type="radio"/> 82.488kHz	100%

Figure 2-10 Clamp Frequency Selection Screen in Clamp Frequency Mode

Press the Signal Select button, , to activate or deactivate the Signal Select feature. The Signal Select icon is displayed on the operational display screen when activated.

2.2.3 Frequency Menu - Inductive Antenna Connection Mode

Inductive antenna connection mode enables the operator to select one active frequency.

The desired frequency settings menu is configured using the three-button navigational keypad. Press <Select> to open the inductive frequency settings menu. Press <Menu> to return to the previous screen.

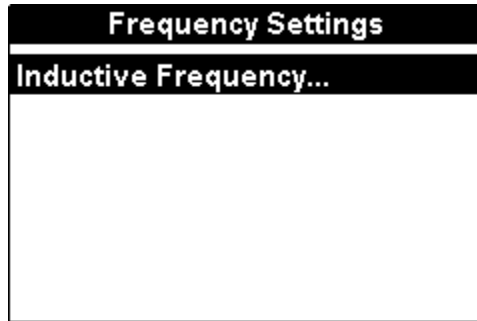



Figure 2-11 Inductive Frequency Menu Screen in Frequency Settings

The desired frequency is configured using the three-button navigational keypad. Press the up/down arrows to select the desired frequency. Press <Select> to activate the desired frequency.

Repeatedly pressing the output level control button, , allows the operator to configure the output power of the selected frequency. The applied output can be increased incrementally by 10%, 25%, 50%, 75%, or 100% of maximum power.

Press <Select> to return to the inductive frequency menu screen. Press <Menu> to return to the operational display screen.

	Inductive Frequency	Output
<input type="radio"/>	9.820kHz	100%
<input type="radio"/>	82.488kHz	100%
<input checked="" type="radio"/>	166kHz	100%

Figure 2-12 Frequency Menu Screen in Inductive Antenna Mode

2.3 System Settings Menu

The *i5000* Transmitter system menu allows the operator to configure the desired system settings. The desired system settings menu is configured using the three-button navigational keypad. Press the up/down arrows to select the desired option. Press <Select> to open the system settings menu option. Press <Menu> to return to the previous screen.

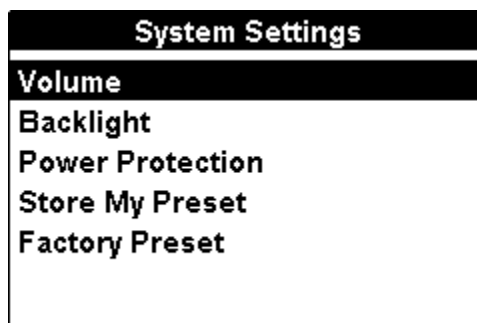

Figure 2-13 System Menu Screen

2.3.1 System Settings Menu – Volume

Selecting Volume allows the operator to set the transmitter volume level – OFF, low, medium, or high.

The desired volume level is configured using the three-button navigational keypad. Press the left/right arrows to select the desired volume level. Press <Select> to activate the desired volume level. The transmitter automatically returns to the operational display screen and the selected display indicator icon is visible.

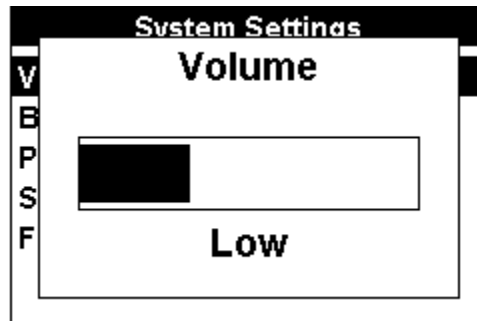

Figure 2-14 Volume Control Selection Screen in System Menu

2.3.2 System Settings Menu – Backlight

Selecting Backlight allows the operator to set the transmitter operational display backlight ON – always **ON** or **Auto** (during configuration or pressing control buttons).

The backlight is configured using the three-button navigational keypad. Press the left/right arrows to select the desired setting. Press <Select> to activate the desired setting. The transmitter automatically returns to the operational display screen.

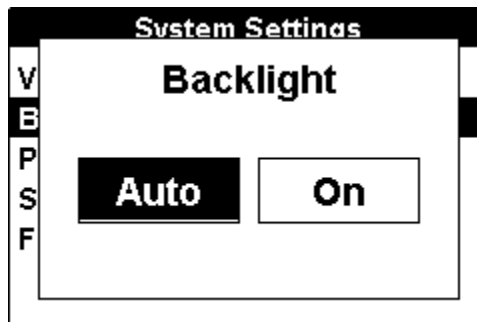

Figure 2-15 Backlight Selection Screen in System Settings

2.3.3 System Menu – Power Protection

Selecting Power Protection allows the operator to set the transmitter's Power Protection feature – always **On** or **Auto** (recommended).

The Power Protection feature is configured using the three-button navigational keypad. Press the left/right arrows to select the desired setting. Press <Select> to activate the desired setting. The transmitter automatically returns to the operational display screen and the selected display indicator icon is visible.

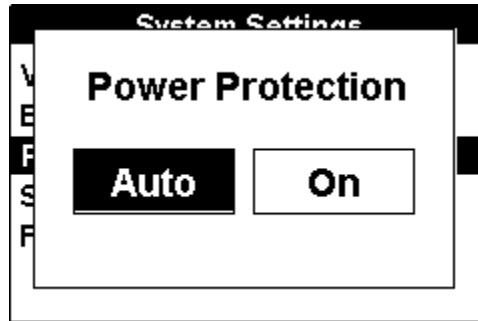

Figure 2-16 Power Protection Selection Screen in System Settings

	Power Protection is designed to protect the TRANSMITTER ONLY from catastrophic failure. The operator should follow all applicable safety rules to prevent personal danger.
	Always de-energize and ground all cables before connecting. The operator should follow all applicable safety rules to prevent personal danger.
	Never connect the transmitter leads to live voltage!
	Always insert and connect the earth grounding rods before turning on the transmitter. Never pull out an earth grounding rod as long as the generator is switched on!
	Power Protection does protect the transmitter if the connected target line becomes energized after the initial connection of the leads and the transmitter is switched to the ON state.

2.3.4 System Menu – Store My Preset

Selecting Store My Preset allows the operator to save the transmitter’s current configured operational conditions – **No** or **Yes**, as the preset state.

The Store My Preset feature is configured using the three-button navigational keypad. Press the left/right arrows to select the desired setting. Press <Select> to activate the desired setting. The transmitter automatically returns to the operational display screen.

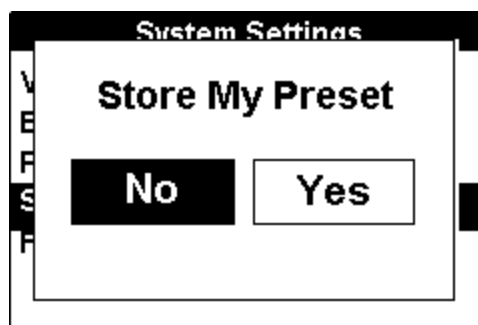

Figure 2-17 Store My Preset Selection Screen in System Settings

2.3.5 System Menu – Factory Preset

Selecting Factory Preset allows the operator to reset the transmitter’s operational conditions to the recommended factory settings.

The Factory Preset feature is configured using the three-button navigational keypad. Press the left/right arrows to select the desired setting. Press <Select> to activate the desired setting. The

transmitter automatically returns to the operational display screen.

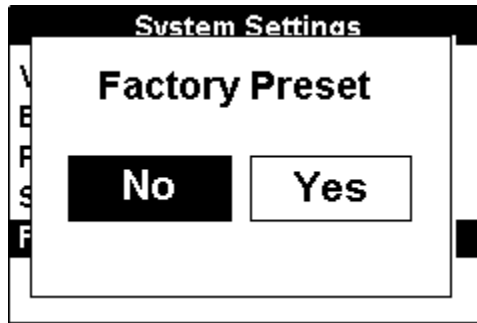

Figure 2-18 Factory Preset Selection Screen in System Settings

2.4 Bluetooth Menu

The *i5000* Bluetooth menu allows the operator to configure the desired operational setting for wireless data and image transmission.

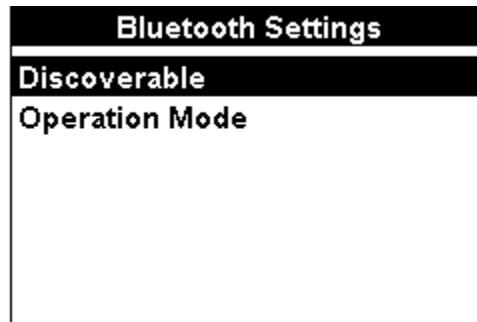

Figure 2-19 Bluetooth Selection Menu Screen

2.4.1 Bluetooth Settings – Discoverable

Selecting Discoverable allows the operator to configure the transmitter’s wireless Bluetooth transmission feature. If activated, the transmitter automatically searches for surrounding Bluetooth-enabled devices such as the *i5000* Receiver.

The Discoverable state feature is configured using the three-button navigational keypad. Press the up/down arrows to select the Discoverable option. Press <Select> to activate the desired setting. The transmitter automatically returns to the operational display screen.

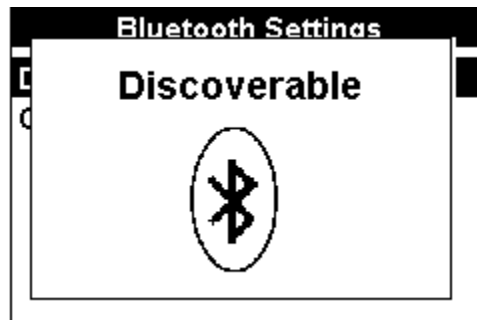

Figure 2-20 Discoverable Selection Screen in Bluetooth Settings

2.4.2 Bluetooth Settings – Operation Mode

Selecting Operation Mode allows the operator to configure the transmitter’s Bluetooth wireless transmission feature **ON** or **OFF**.

The Operation Mode feature is configured using the three-button navigational keypad. Press the left/right arrows to select the desired setting. Press <Select> to activate the desired setting. The transmitter automatically returns to the operational display screen.

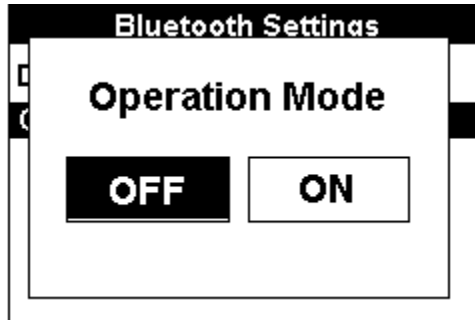

Figure 2-21 Operation Mode Selection Screen in Bluetooth Settings

2.5 My Preset State Menu

The *i5000* My Preset State allows the operator to return the transmitter’s operational conditions to the configured and saved preset state by selecting – **No** or **Yes**.

The My Preset State feature is configured using the three-button navigational keypad. Press the left/right arrows to select the desired setting. Press <Select> to activate the desired setting. The transmitter automatically returns to the operational display screen.

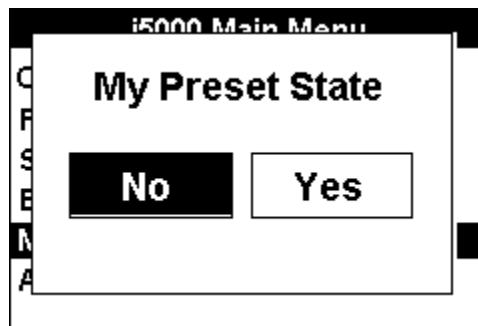

Figure 2-22 My Preset State Selection in i5000 Main Menu

2.6 About i5000 Menu

The About i5000 menu allows the operator to view the transmitter’s serial number, hardware, and firmware information. Press <Menu> to return to the previous screen.

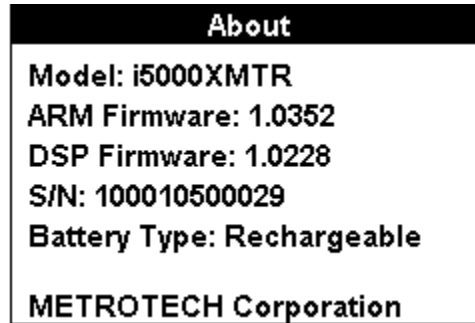



Figure 2-23 About i5000 Menu Screen

3 Sheath Fault Locating (SFL)

The Sheath Fault Locating (SFL) feature is available in Direct (Conductive) Connection mode

only. Press the SFL button, , to activate operation.

Frequency selection is not configurable through the frequency menu screen. Frequency selection – 9.82kHz or 82kHz, is activated by pressing the frequency button, . The active frequency is displayed on the operational display screen.

1 Service and Maintenance

1.1 Maintenance

The only routine maintenance required for the equipment and accessories is to test and recharge or replace, if necessary, the batteries. A continuous battery test is a standard feature, making it easy to check the condition of the batteries at any time.

The *i5000* receiver is designed for rugged outdoor use, but rough handling should be avoided. Keep the equipment dry, clean, and free of grit. Store the *i5000* (in a dry carrying case) in a cool, dry place. Do not expose to excessive temperatures.

We recommend checking the receiver battery status before each use, preferably before leaving for the job site.

1.2 Service Center Information

If the equipment does not function properly, replace the batteries as described above. If the equipment still malfunctions, contact one of the Metrotech Customer Service departments:

Vivax-Metrotech Corporation

3251 Olcott Street,
Santa Clara, CA 95054, USA
Website : www.vivax-metrotech.com
Sales & Sales Support:
T/Free : +1-800-446-3392
Tel : +1-408-734-1400
Fax : +1-408-734-1415
Email : sales@vxmt.com

Application Support:

T/Free : +1-800-624-6210
Tel : +1-408-454-7159
Fax : +1-408-743-5597
Email : applications@vxmt.com

Service & Repairs:

T/Free : +1-800-638-7682
Tel : +1-408-962-9990
Fax : +1-408-734-1799
Email : service@vxmt.com

All Other Department:

T/Free : +1-877-330-1647
Tel : +1-408-734-3880
Fax : +1-408-962-9993

Canada

Vivax Canada Inc.
400 Esna Park Drive,
Unit 17, Markham,
Ontario, L3R 3K2, Canada
Tel : +1-289-846-3010
Website : www.vivax-metrotech.com
Email : CanadianSales@vxmt.com

Europe

SebaKMT
Seba Dynatronic
Mess-und Ortungstechnik GmbH
Dr.-Herbert-Iann-Str. 6,
96148 Baunach, Germany.
Tel : +49-9544-680
Fax : +49-9544-2273
Website : www.sebakmt.com
Email : service@sebakmt.com

Australasia

SebaKMT AUS
Unit 1, 176 South Creek Road,
Cromer NSW 2009, Australia
Tel : +61-2-9972-9244
Fax : +61-2-9972-9433
Website : www.sebakmtaus.com
Email : sales@sebakmtaus.com
service@sebakmtaus.com

China

Leidi Utility Supply (Shanghai) Ltd.
Rm405 3rd Building No. 641, Tianshan Rd,
Shanghai, China 200336
Tel : +86-21-5187-3880
Fax : +86-21-5168-5880
Website : www.leidi.com
Email : info@leidi.cn

Or call the Metrotech headquarters for the nearest authorized Metrotech repair station. Metrotech also manufactures and distributes these instruments: Pipe and Cable Locators, Ferromagnetic Locators, Fiber Optic Cable Locating System, Sheath Fault Locators, Electronics Marker Locators, Acoustic Water Leak Detectors, Water Leak Sound Correlators and Data Loggers. For more details, see our website www.metrotech.com.

2 Warranty

THERE ARE NO WARRANTIES, EXPRESSED OR IMPLIED, INCLUDING ANY WARRANTY OF MERCHANTABILITY, BEYOND THOSE STATED HEREIN.

Metrotech warrants its equipment to be free from defects in workmanship and material under normal and proper use and service for one year from date of purchase by original user. Metrotech assumes no obligation to repair or replace equipment which has been altered or repaired by other than a Metrotech-approved procedure, been subject to misuse, misapplication, improper maintenance, negligence, or accident; has had its serial number or any part thereof altered, defaced or removed; or been used with parts other than those approved by Metrotech. Warranty does not include batteries. Expendable items such as fuses and lamps are excluded. Any detection product proved defective under this warranty will be repaired or replaced free of charge at the Metrotech Corporation factory or approved Metrotech repair station. The equipment should be returned to our factory by prepaid transportation after requesting and receiving return authorization from our Customer Service Department. Metrotech's obligations are limited to repair or replacement of broken or defective parts which have not been abused, misused, altered, or accidentally damaged, or at the option of Metrotech, to refund of the purchase price. Metrotech assumes no liability for removal or installation costs, consequential damages, or contingent expenses of any other nature.

3 Copyright Notice

The information contained in this document is for informational purposes only and is subject to change without notice. Metrotech Corporation makes no warranty of any kind with regard to the information contained in this manual, including but not limited to the implied warranties of merchantability and fitness for a particular purpose. Metrotech shall not be liable for errors contained herein, nor for incidental or consequential damages from the furnishing of this information.

This manual contains proprietary information that is protected by copyright. All rights are reserved. No part of this manual may be photocopied, reproduced, magnetically or electronically stored, transmitted, or translated into another language without the prior written consent of Metrotech Corporation.

Bluetooth® is a registered trademark of Bluetooth SIG Inc.

© Metrotech Corporation 2008 - All Rights Reserved