

Leica DD120, DD130 Series Locators & Accessories



User Manual
Version 1.0
English

- when it has to be **right**

Leica
Geosystems

Introduction

Purchase

Congratulations on the purchase of a Leica Detection product.



This manual contains important safety directions as well as instructions for setting up the product and operating it. Refer to "1 Safety Directions" for further information.

Read carefully through the User Manual before you switch on the product.



Product identification

The model and serial number of your product are indicated on the type plate. Always refer to this information when you need to contact your agency or Leica Geosystems authorised service centre.

Validity of this manual

This manual applies to the Leica Detection DD120, DD130 Series Locators, DA Series Transmitters and Detection Accessories. Differences between the models are marked and described.

Available documentation

Name	Description/Format		
Leica DD120, DD130 Series Locators & Accessories Quick Guide	Provides an overview of the product together with technical data and safety directions. Intended as a quick reference field guide.	✓	✓
Leica DD120, DD130 Series Locators & Accessories User Manual	All instructions required in order to operate the product to a basic level are contained in the User Manual. Provides an overview of the product together with technical data and safety directions.		✓

Refer to the following resources for all Leica DD120, DD130 documentation/software:

- the Leica USB documentation card
- <https://myworld.leica-geosystems.com>



myWorld@Leica Geosystems (<https://myworld.leica-geosystems.com>) offers a wide range of services, information and training material.

With direct access to myWorld, you are able to access all relevant services whenever it is convenient for you.

Service	Description
myProducts	Add all products that you and your company own and explore your world of Leica Geosystems: View detailed information on your products and update your products with the latest software and keep up-to-date with the latest documentation.

Service	Description
myService	View the current service status and full service history of your products in Leica Geosystems service centres. Access detailed information on the services performed and download your latest calibration certificates and service reports.
mySupport	Create new support requests for your products that will be answered by your local Leica Geosystems Support Team. View the complete history of your support requests and view detailed information on each request in case you want to refer to previous support requests.
myTraining	Enhance your product knowledge with Leica Geosystems Campus - Information, Knowledge, Training. Study the latest online training material on your products and register for seminars or courses in your country.
myTrustedServices	Add your subscriptions and manage users for Leica Geosystems Trusted Services, the secure software services, that assist you to optimise your workflow and increase your efficiency.

Table of Contents

1	Safety Directions	6
1.1	General	6
1.2	Definition of Use	7
1.3	Limits of Use	7
1.4	Responsibilities	7
1.5	Hazards of Use	8
	1.5.1 General	8
	1.5.2 Using the Product with a Signal Transmitter	12
1.6	Electromagnetic Compatibility EMC	13
1.7	FCC Statement, Applicable in U.S.	14
2	Description of the System	17
2.1	System Information	17
2.2	System Components	17
2.3	Locator Components	18
2.4	Signal Transmitter Components	18
2.5	Li-Ion Battery Pack	18
3	Operation of the Locator	20
3.1	Display Panel Overview	20
3.2	Locator Setup and Information	20
3.3	Hazard Zone	22
3.4	How to Locate a Utility	23
3.5	Search Modes	23
4	Operation of the Transmitter	25
4.1	Keyboard	25
4.2	Turning On / Turning Off	25
5	Applications	26
5.1	How to Pinpoint a Utility	26
5.2	How to Trace a Utility	27
5.3	How to Conduct a Sweep Search	27
5.4	Using the Transmitter in Induction Mode	29
	5.4.1 General Information	29
	5.4.2 Induction Mode: Nulling-Out Method	30
	5.4.3 Induction Mode: Parallel-Sweep Method	31
	5.4.4 Induction Mode: Radial-Sweep Method	32
5.5	Using the Transmitter in Connection Mode	33
	5.5.1 General Information	33
	5.5.2 Direct Connection Mode	34
5.6	How to Use the Trace Rod	35
	5.6.1 General Information	35
	5.6.2 Locating a Utility Using the Trace Rod	36
5.7	How to Use the Transmitter Clamps	39
	5.7.1 General Information	39
	5.7.2 Using a Transmitter Clamp to connect to Cable Utilities	39
5.8	How to Use the Property Plug Connector	40
	5.8.1 General Information	40
	5.8.2 Locating a Utility Using the Property Plug Connector	41
5.9	How to Use the Sondes	42
	5.9.1 General Information	42
6	Estimating Depth and Current of a Utility	44
6.1	Utility Line Depth	44
6.2	Sonde Depth	45

6.3	Depth Code Information	45
6.4	Utility Current Measurement	46
7	Connectivity	49
7.1	Transmitter USB Connectivity	49
8	Batteries	50
8.1	Locators Batteries	50
8.2	Charging the Li-Ion Battery Pack	50
8.3	Operating Principles	52
9	Functional Checks	53
9.1	Locator Health Check	53
9.2	Locator Functional Check	53
9.3	Functional Check of the Transmitter	54
9.4	Functional Check of the Trace Rod	55
9.5	Functional Check of the Sonde	56
10	Care and Transport	58
10.1	Transport	58
10.2	Storage	58
10.3	Cleaning and Drying	58
11	Technical Data	59
11.1	Conformity to National Regulations	59
11.2	Transmitter Technical Data	59
11.3	Locator Technical Data	60
11.4	Conductive Rod Technical Data	62
11.5	Property Plug Connector Technical Data	62
Appendix A	World Frequency Zones	64

1 Safety Directions

1.1 General

DANGER

Incorrect power setting

The locator may fail to detect electrical services in power mode.

Precautions:

- ▶ Before use, verify the locator is setup to be compatible with mains frequency supply in your country. Options are 50 or 60 Hz.
- ▶ Refer to "A World Frequency Zones" for more information.
- ▶ Contact your agency or Leica Geosystems authorised service workshop if your unit is incorrectly configured for your region.

Description

The following directions enable the person responsible for the product, and the person who actually uses the equipment, to anticipate and avoid operational hazards.

The person responsible for the product must ensure that all users understand these directions and adhere to them.

About warning messages



Warning messages are an essential part of the safety concept of the instrument. They appear wherever hazards or hazardous situations can occur.

Warning messages...

- make the user alert about direct and indirect hazards concerning the use of the product.
- contain general rules of behaviour.

For the users' safety, all safety instructions and safety messages shall be strictly observed and followed! Therefore, the manual must always be available to all persons performing any tasks described here.

DANGER, WARNING, CAUTION and **NOTICE** are standardised signal words for identifying levels of hazards and risks related to personal injury and property damage. For your safety, it is important to read and fully understand the following table with the different signal words and their definitions! Supplementary safety information symbols may be placed within a warning message as well as supplementary text.

Type	Description
 DANGER	Indicates an imminently hazardous situation which, if not avoided, will result in death or serious injury.
 WARNING	Indicates a potentially hazardous situation or an unintended use which, if not avoided, could result in death or serious injury.
 CAUTION	Indicates a potentially hazardous situation or an unintended use which, if not avoided, may result in minor or moderate injury.
NOTICE	Indicates a potentially hazardous situation or an unintended use which, if not avoided, may result in appreciable material, financial and environmental damage.

Type	Description
	Important paragraphs which must be adhered to in practice as they enable the product to be used in a technically correct and efficient manner.

1.2

Definition of Use

Intended use

The products are intended to be used for the following applications:

General

- Detection and localisation of underground utilities: metallic cables and pipes.

Locator

- Detection and localisation of utilities with the use of approved accessories or a signal transmitter.
- Estimation of the depth of an underground utility, or accessory.

Reasonably foreseeable misuse

- Use of the product without instruction.
- Use outside of the intended use and limits.
- Disabling safety systems.
- Removal of hazard notices.
- Opening the product using tools, for example screwdriver, unless this is permitted for certain functions.
- Modification or conversion of the product.
- Use after misappropriation.
- Use of products with recognisable damages or defects.
- Use with accessories from other manufacturers without the prior explicit approval of Leica Geosystems.
- Inadequate safeguards at the working site.

1.3

Limits of Use

Environment

Suitable for use in an atmosphere appropriate for permanent human habitation: not suitable for use in aggressive or explosive environments.

WARNING

Working in hazardous areas, or close to electrical installations or similar situations.

Life Risk.

Precautions:

- ▶ Local safety authorities and safety experts must be contacted by the person responsible for the product before working in such conditions.

1.4

Responsibilities

Manufacturer of the product

Leica Geosystems AG, CH-9435 Heerbrugg, hereinafter referred to as Leica Geosystems, is responsible for supplying the product, including the user manual and original accessories, in a safe condition.

Person responsible for the product

The person responsible for the product has the following duties:

- To understand the safety instructions on the product and the instructions in the user manual.
- To ensure that it is used in accordance with the instructions.
- To be familiar with local regulations relating to safety and accident prevention.
- To inform Leica Geosystems immediately if the product and the application becomes unsafe.
- To ensure that the national laws, regulations and conditions for the operation of the product are respected.

1.5

Hazards of Use

1.5.1

General

NOTICE

Dropping, misusing, modifying, storing the product for long periods or transporting the product

Watch out for erroneous measurement results.

Precautions:

- ▶ Periodically carry out test measurements and perform the field adjustments indicated in the User Manual, particularly after the product has been subjected to abnormal use as well as before and after important measurements.

DANGER

Because of the risk of electrocution, it is dangerous to use the product in the vicinity of electrical installations such as power cables or electrical railways.

Precautions:

- ▶ Keep at a safe distance from electrical installations. If it is essential to work in this environment, first contact the safety authorities responsible for the electrical installations and follow their instructions.

WARNING

Working on or near live electrical utilities may cause you to receive an electric shock.

Precautions:

- ▶ Do not exceed equipment's recommended ratings and instructions of use.
 - ▶ Inspect equipment's cables and accessories for damage, do not use if faulty.
 - ▶ Do not work on electrically live power utilities unless you are properly qualified.
 - ▶ Use personal protective equipment rated for the utilities voltage and current.
 - ▶ Familiarise yourself with National and Work regulations governing safety and accident prevention.
-

 **WARNING**

Distraction/loss of attention

During dynamic applications, for example stakeout procedures, there is a danger of accidents occurring if the user does not pay attention to the environmental conditions around, for example obstacles, excavations or traffic.

Precautions:

- ▶ The person responsible for the product must make all users fully aware of the existing dangers.

 **WARNING**

The absence of a positive indication does not guarantee the non-existence of a utility.

Utilities without a detectable signal may be present.

The locators can only locate non-metallic utilities such as plastic pipes, typically used by the water and gas utilities, with the use of appropriate accessories.

Precautions:

- ▶ Always excavate with care.

 **WARNING**

Depth reading on locator might differ from actual depth of utility

When taking a depth reading, the depth is calculated as distance to the centre of a utility or to a sonde within the utility. Depending on the diameter of a utility, the depth reading might differ from the actual depth of the utility. This specifically applies when the signal for depth estimation is produced by a sonde lying in a large-diameter pipe or duct.

Precautions:

- ▶ Always take into account allowances for the diameter of a utility.

 **WARNING**

Inadequate securing of the working site.

This can lead to dangerous situations, for example in traffic, on building sites and at industrial installations.

Precautions:

- ▶ Always ensure that the working site is adequately secured.
- ▶ Adhere to the regulations governing safety, accident prevention and road traffic.

 **WARNING**

Inappropriate mechanical influences to batteries

During the transport, shipping or disposal of batteries it is possible for inappropriate mechanical influences to constitute a fire hazard.

Precautions:

- ▶ Before shipping the product or disposing it, discharge the batteries by the product until they are flat.
- ▶ When transporting or shipping batteries, the person in charge of the product must ensure that the applicable national and international rules and regulations are observed.
- ▶ Before transportation or shipping, contact your local passenger or freight transport company.

 **WARNING**

A hazardous signal can be present at the transmitter output when used in connection mode and on the attached accessories and live utility itself.

Precautions:

- ▶ Take care when handling exposed or non-insulated connections. Notify others who may be working on or around the utility.

 **WARNING**

Exposure of batteries to high mechanical stress, high ambient temperatures or immersion into fluids

This can cause leakage, fire or explosion of the batteries.

Precautions:

- ▶ Protect the batteries from mechanical influences and high ambient temperatures. Do not drop or immerse batteries into fluids.

 **WARNING**

Short circuit of battery terminals

If battery terminals are short circuited e.g. by coming in contact with jewellery, keys, metallised paper or other metals, the battery can overheat and cause injury or fire, for example by storing or transporting in pockets.

Precautions:

- ▶ Make sure that the battery terminals do not come into contact with metallic objects.

WARNING

Unauthorised opening of the product

Either of the following actions may cause you to receive an electric shock:

- Touching live components
- Using the product after incorrect attempts were made to carry out repairs

Precautions:

- ▶ Do not open the product!
- ▶ Only Leica Geosystems authorised service centres are entitled to repair these products.

WARNING

Improper disposal

If the product is improperly disposed of, the following can happen:

- If polymer parts are burnt, poisonous gases are produced which may impair health.
- If batteries are damaged or are heated strongly, they can explode and cause poisoning, burning, corrosion or environmental contamination.
- By disposing of the product irresponsibly you may enable unauthorised persons to use it in contravention of the regulations, exposing themselves and third parties to the risk of severe injury and rendering the environment liable to contamination.

Precautions:



The product must not be disposed with household waste. Dispose of the product appropriately in accordance with the national regulations in force in your country. Always prevent access to the product by unauthorised personnel.

Product-specific treatment and waste management information can be received from your Leica Geosystems distributor.

WARNING

Improperly repaired equipment

Risk of injuries to users and equipment destruction due to lack of repair knowledge.

Precautions:

- ▶ Only Leica Geosystems authorised service centres are entitled to repair these products.

 DANGER**Clipping a transmitter clamp around a live utility**

When a transmitter clamp is clipped around a live utility, a hazardous signal might be present on the utility or at the transmitter plug connector, causing you to receive an electric shock.

Precautions:

- ▶ Do not clip a transmitter clamp around live utilities that have impaired or no insulation.
 - ▶ Always ensure that the transmitter plug connector is connected to the transmitter before you clip the transmitter clamp around a live utility.
-

 DANGER**Connecting the cable set of the transmitter to a live utility**

Connecting the cable set of the transmitter directly to a live utility can cause you to receive an electric shock.

Precautions:

- ▶ Never connect the cable set of the transmitter directly to a live electrical utility.
-

 DANGER**Power output of signal transmitter**

The signal transmitter can output potentially lethal voltages!

Precautions:

- ▶ Take care when using the maximum power output of the signal transmitter.
 - ▶ Take care when handling exposed or non-insulated connections, including the transmitter's cable set, the earth pin and the connection to the utility.
 - ▶ Notify others who may be working on or around the utility.
-

 WARNING**Removing the battery pack of the signal transmitter**

Removing the battery pack of the signal transmitter might cause you to receive an electric shock.

Precautions:

- ▶ Switch the signal transmitter off and remove any cable set or accessories from the connection socket before removing the battery pack.
-

 WARNING**Battery pack of the signal transmitter may get hot after prolonged use.**

Risk of burning injuries.

Precautions:

- ▶ Avoid touching the hot battery pack.
 - ▶ Allow the battery pack to cool down before removing it.
-

Description

The term Electromagnetic Compatibility is taken to mean the capability of the product to function smoothly in an environment where electromagnetic radiation and electrostatic discharges are present, and without causing electromagnetic disturbances to other equipment.

 WARNING**Electromagnetic radiation**

Electromagnetic radiation can cause disturbances in other equipment.

Precautions:

- ▶ Although the product meets the strict regulations and standards which are in force in this respect, Leica Geosystems cannot completely exclude the possibility that other equipment may be disturbed.
-

 CAUTION**Use of the product with accessories from other manufacturers. For example field computers, personal computers or other electronic equipment, non-standard cables or external batteries**

This may cause disturbances in other equipment.

Precautions:

- ▶ Use only the equipment and accessories recommended by Leica Geosystems.
 - ▶ When combined with the product, they meet the strict requirements stipulated by the guidelines and standards.
 - ▶ When using computers, two-way radios or other electronic equipment, pay attention to the information about electromagnetic compatibility provided by the manufacturer.
-

 CAUTION**Intense electromagnetic radiation. For example, near radio transmitters, transponders, two-way radios or diesel generators**

Although the product meets the strict regulations and standards which are in force in this respect, Leica Geosystems cannot completely exclude the possibility that function of the product may be disturbed in such an electromagnetic environment.

Precautions:

- ▶ Check the plausibility of results obtained under these conditions.
-

CAUTION

Electromagnetic radiation due to improper connection of cables

If the product is operated with connecting cables attached at only one of their two ends, for example external supply cables, interface cables, the permitted level of electromagnetic radiation may be exceeded and the correct functioning of other products may be impaired.

Precautions:

- ▶ While the product is in use, connecting cables, for example product to external battery, product to computer, must be connected at both ends.

WARNING

Use of product with radio or digital cellular phone devices

Electromagnetic fields can cause disturbances in other equipment, in installations, in medical devices, for example pacemakers or hearing aids and in aircraft. It can also affect humans and animals.

Precautions:

- ▶ Although the product meets the strict regulations and standards which are in force in this respect, Leica Geosystems cannot completely exclude the possibility that other equipment can be disturbed or that humans or animals can be affected.
- ▶ Do not operate the product with radio or digital cellular phone devices in the vicinity of filling stations or chemical installations, or in other areas where an explosion hazard exists.
- ▶ Do not operate the product with radio or digital cellular phone devices near to medical equipment.
- ▶ Do not operate the product with radio or digital cellular phone devices in aircraft.
- ▶ Do not operate the product with radio or digital cellular phone devices for long periods with the product immediately next to your body.

1.7

FCC Statement, Applicable in U.S.



The greyed paragraph below is only applicable for products without radio.

WARNING

This equipment has been tested and found to comply with the limits for a Class B digital device, pursuant to part 15 of the FCC rules.

These limits are designed to provide reasonable protection against harmful interference in a residential installation.

This equipment generates, uses and can radiate radio frequency energy and, if not installed and used in accordance with the instructions, may cause harmful interference to radio communications. However, there is no guarantee that interference will not occur in a particular installation.

If this equipment does cause harmful interference to radio or television reception, which can be determined by turning the equipment off and on, the user is encouraged to try to correct the interference by one or more of the following measures:

- Reorient or relocate the receiving antenna.
- Increase the separation between the equipment and the receiver.
- Connect the equipment into an outlet on a circuit different from that to which the receiver is connected.
- Consult the dealer or an experienced radio/TV technician for help.

CAUTION



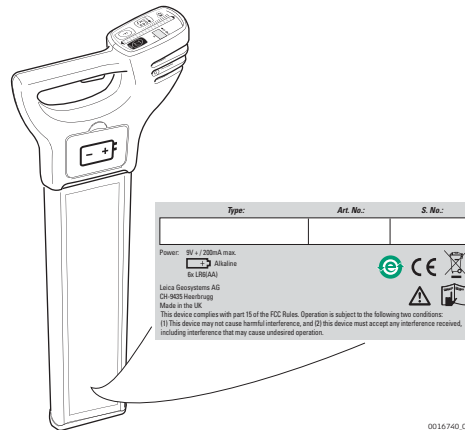

Changes or modifications not expressly approved by Leica Geosystems for compliance could void the user's authority to operate the equipment.

Labelling DD120, DD130 loca- tors



Labelling DA series transmitters

Power: 7.4V  / 7.2Ah / 0.5A
Leica Geosystems AG
CH - 9435 Heerbrugg
Switzerland

<input type="text"/>	<input type="text"/>	<input type="text"/>
Type	Art.No.	Ser.No.

This device complies with part 15 of the FCC Rules. Operation is subject to the following two conditions:
(1) This device may not cause harmful interference, and (2) this device must accept any interference received, including interference that may cause undesired operation.

Made in the UK



13298_003

2

Description of the System

2.1

System Information

General description

Locators are used to detect buried conductive utilities that emit an electromagnetic signal. Such a signal is generated as an electrical current passes through the utility.

Signal transmitters are used to apply a distinct signal to utilities with the following intention:

- To improve the detection success.
- To trace the route of a utility.
- To make a depth or current measurement.

Accessories are used with the locator and transmitter to localise the position of utilities, including some that are non-metallic.

The locators and transmitters described within this manual greatly facilitate the search process and help to reduce the dangers and costs associated with utility strikes. However, electromagnetic location depends on the utilities being conductive (metallic) and emitting a signal as current passes through them.

☞ Keep in mind that a locator on its own cannot detect all utilities. Take care when excavating. We recommend that you adopt a safe system which includes the planning of the search process in advance, the use of utility maps, the use of locators and transmitters, and the use of safe digging practices.

2.2

System Components



The delivered components depend on the package ordered.

Available system components

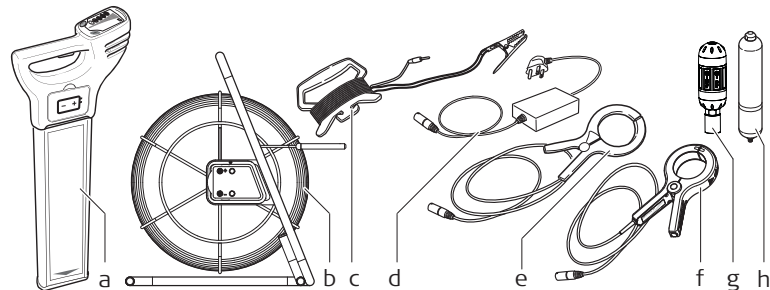

0016741.001

- a DD120, DD130 Locators
- b Trace Rod (non-metallic utility tracer)
- c Transmitter Cable Set Extension
- d Property Plug Connector
- e Transmitter Clamp
- f Transmitter Clamp
- g Sonde
- h Sonde

2.3

Locator Components

Description of components
DD120, DD130 locators

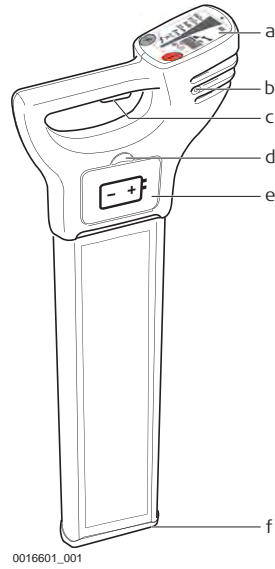

- a **Display panel**
Contains the operational controls.
- b **Speakers**
(mounted internally left and right)
Active at power on and when a signal is detected.
- c **On/Off trigger**
Press and hold the trigger to activate the Locator.
Release the trigger to deactivate.
- d **Battery hatch release**
Pressing the release button unlocks the battery hatch allowing access to the battery compartment.
- e **Battery compartment**
6 x LR6 (AA) alkaline batteries are used. Replace all batteries when indicated.
- f **Case foot**



The case foot can be replaced if it is worn.
Contact your agency or Leica Geosystems authorised service workshop.

2.4

Signal Transmitter Components

Description of transmitter components



- a Accessory compartment
- b Connection socket
- c Battery compartment and USB port
- d Signal transmitter keyboard
- e Speaker
- f Induction arrow

2.5

Li-Ion Battery Pack

Signal Transmitter Li-Ion pack

The Li-Ion pack is delivered with an energy content as low as possible and needs to be woke up prior to use.

To wake up the Li-Ion pack, do the following:

1. Connect the charger plug into the charge jack on the Li-Ion pack.



2. Plug the connector into a suitable power source.

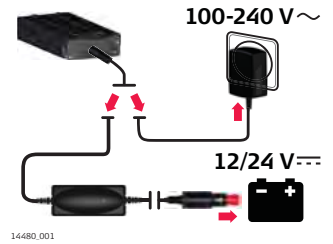

☞ The Li-Ion pack should be fully charged before use.

Result:

The small LED next to the charge jack flashes at a fast rate to indicate the wake up process, then flashes at a slower rate to indicate that the Li-Ion pack is active and charging.

☞ Applicable to the DD120, DD130 locators and DA Signal Transmitters.

3

Operation of the Locator

3.1

Display Panel Overview

DD120, DD130 panel overview

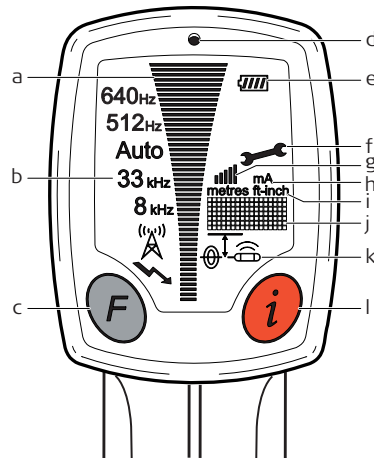

0016743_001

- a **Signal Strength Indicator**
Indicates the response of the Locator to a signal (utility).
- b **Mode Indicators**
Displays the selected mode: Power, Radio, 8 kHz, 33 kHz, Auto, (512 Hz and 640 Hz on DD130 series model). As shown, from bottom to top.
- c **Function Button**
Selects operating mode.
- d **Light Sensor**
Automatically switches the displays backlight on or off to suit light conditions.
- e **Battery Indicator**
Indicates the battery condition. Segment illumination decreases as battery condition declines. Replace the batteries when the battery indicator is empty.
- f **Wrench**
Indicates the Locator requires periodic service or unit is faulty.
- g **Numeric Signal Strength Indicator (SSi)**
Symbol Static: SSi is enabled.
SSi is disabled.
- h **Current Indicator (DD130 series model)**-Indicates the amount current flowing through a service which is applied by the Transmitter. This is measured in milliamperes (mA).
- i **Measurement Unit**
Indicates depth indication is in metric or feet and inches.
- j **Display Readout**
Alpha numeric matrix indicates system set up and depth indication.
- k **Depth Mode Indicators**
Indicates a depth reading to a utility or a Sonde. Depth icon used to indicate Hazard Zone status.
- l **i Button**
Used to access the user settings and to provide a depth readout for Depth locators.

3.2

Locator Setup and Information

Turning on and off the DD120, DD130

Press and hold the trigger to turn on and operate the locator.
Release the trigger to turn off the locator.

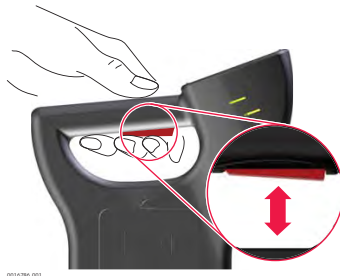

Locator settings

The DD120, DD130 locators offer a range of settings which the operator can adjust to their own preference. It also displays additional service and contact information as detailed.

Setting	Description
EST	Performs a function check on the locators hardware and software, displaying PAS if the Locator is within predefined tolerance or ERR if the locator is not.
H.Z	Switches hazard zone on or off.
VOL	Adjust volume level (0 to 10).
HLD	Adjust peak hold duration (0 to 5 seconds).
SSI	Displays a numeric signal strength indicator.
CST	Adjusts display's contrast (0 to 15).
M/I	Displays unit of measurement.
CAL	Displays the next service date DD/MM/YY.
CON	Displays supplier/company name.
TEL	Displays supplier/company telephone number.
I.D	Displays the operator's name.
PWR	Displays the power mode regional setting. Refer to World Frequency Zones for more information.
SR#	Displays unit serial number.
VER	Displays software version.
LST (DD130 series model)	Sets the Locators start up mode. On: The Locator starts in the last mode of operation used. Off: The Locator starts in Power mode.

Accessing and adjusting the settings

1. Switch the Locator on.
2. Ensure the Locator is in Power mode. If required, press Function Button to select mode.
3. Depress the i Button until the user settings are displayed in the display readout.
4. Press Function Button to toggle through to desired setting.
5. Press i Button to select the setting.
6. Press Function Button to activate/adjust.

- Press i Button to store and exit.

⚠ DANGER

Incorrect power setting

The locator may fail to detect electrical services in power mode.

Precautions:

- ▶ Before use, verify the locator is setup to be compatible with mains frequency supply in your country. Options are 50 or 60 Hz.
- ▶ Refer to "A World Frequency Zones" for more information.
- ▶ Contact your agency or Leica Geosystems authorised service workshop if your unit is incorrectly configured for your region.

Changing the battery

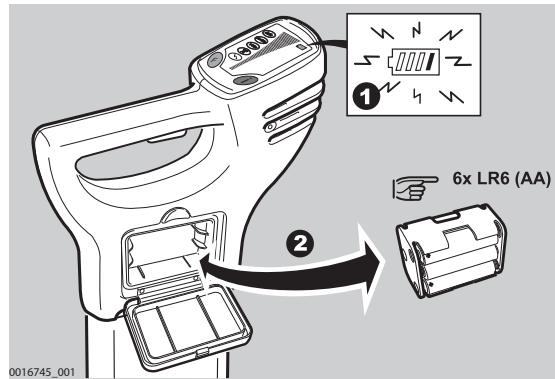

1. Replace or Recharge the batteries when the battery status indicator is empty.
2. Press the release button to unlock the Battery Hatch. Remove the battery holder from the Locator.
3. Replace all batteries with six new LR6 (AA) type alkaline batteries, or remove and recharge the battery pack if rechargeable batteries are fitted.

3.3

Hazard Zone



Description

Provides an additional warning to the close proximity of buried services and functions in the following modes:

- Power
- 8 kHz
- 33 kHz
- Auto Mode (Power mode only)
- 512 Hz & 640 Hz (DD130 series model only)

Description

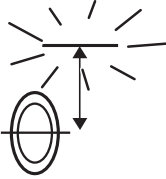
Status indicator	Description
	Hazard zone is switched on.



Status indicator	Description
	Hazard zone on and is alarming.
	Hazard zone is switched off.



3.4 How to Locate a Utility

Status indicator	Test pattern	Info on label
Audio Output	On throughout test sequence	
Signal Strength indicator	Scrolls through in sequence once	
Mode indicators	Briefly illuminated	
Indicator Icons	Briefly illuminated	
Battery indicator	On throughout test sequence	

3.5 Search Modes

Available search modes

Search Mode	Description
Auto mode	<p>Combined detection of Power and Radio modes.</p> <p> This mode facilitates a one-step sweep search process.</p>
Power mode	<p>This mode is used to detect electrical cables.</p> <p> Power mode is dependent on an electrical current flowing through a cable. Keep in mind that not all electrical cables carry a detectable signal and thus pose a serious risk, for example supplies to unilluminated street lights, unoccupied buildings or balanced three-phase cables.</p>
Radio mode	<p>This mode is used to detect metallic pipes or cables, including telecoms and electrical.</p> <p> Radio mode is dependent on reradiated radio waves originating from radio masts. Keep in mind that signal availability can vary or be restricted depending on factors including line of site, signal application or routine mast maintenance.</p>

Search Mode	Description
Signal Transmitter mode	<p>Used in conjunction with a signal transmitter:</p> <ul style="list-style-type: none"> • To improve the detectability of utilities. • To trace a specific utility. • To make a depth or current measurement. <p> Keep in mind the following:</p> <ul style="list-style-type: none"> • Higher frequencies couple onto utilities more easily than lower frequencies. • Higher frequencies travel shorter distances; the higher the frequency the less the distance travelled. • Higher frequencies are likely to couple onto other utilities; the higher the frequency the greater the spread. • Higher frequencies are useful for avoidance activities. <p>Example: A 33 kHz frequency has a greater ability to couple onto other utilities.</p>
Sonde	<p>Used in conjunction with a sonde:</p> <ul style="list-style-type: none"> • To trace the route of a pipe or duct, including non-metallic variants. • To locate a blockage or collapse. • To make a depth measurement. <p> Keep in mind that various sondes are available for specific task-based applications:</p> <ul style="list-style-type: none"> • Sondes with higher frequencies are used for generic pipe or duct tracing. • Lower frequencies (512 Hz, 640 Hz) work best for metal pipes.

How to select a search mode



Press the Function key on the locator keyboard to select a search mode.

WARNING

The absence of a positive indication does not guarantee the non-existence of a utility.

Utilities without a detectable signal may be present.

The locators can only locate non-metallic utilities such as plastic pipes, typically used by the water and gas utilities, with the use of appropriate accessories.

Precautions:

- ▶ Always excavate with care.

4

Operation of the Transmitter

4.1

Keyboard

Transmitter keyboard

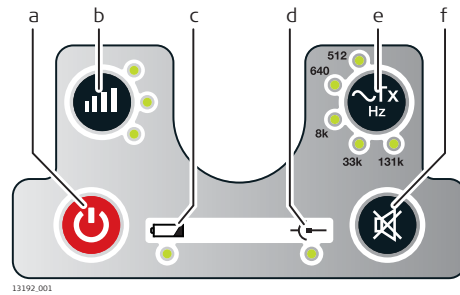

- a Power key
- b Power Output key and LED indicators
- c Low Battery LED indicator
- d Connection Mode LED indicator
- e Frequency key and LED indicators
- f Mute key

4.2

Turning On / Turning Off

Turning on and off the transmitter

Press the Power key to turn the transmitter on or off.

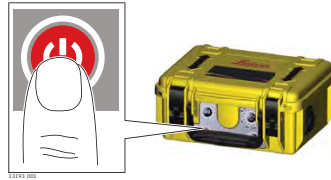

5

Applications

5.1

How to Pinpoint a Utility

Pinpointing process

To help you pinpoint a utility, the locator provides a visual and an audible response.

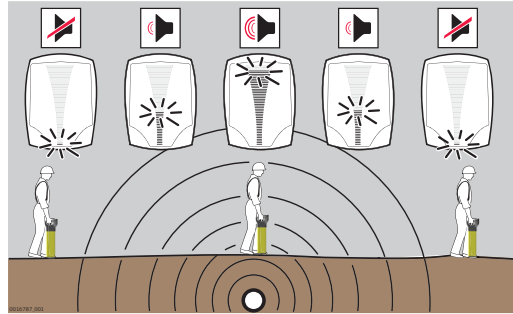

Visual response

When the locator is positioned directly over a utility and at 90° to it, the Locate screen displays a peak reading. Refer to "3.1 Display Panel Overview".

Locate Scale



- Increases when approaching a utility or sonde and decreases when moving away.
- Provides a peak reading when directly over the utility or sonde.
- Decreases when moving away from the utility.

Peak Indicator



- Indicates the highest peak reading on the locate scale.
- Remains at the peak position for a short period of time before falling back.

Numeric Peak Indicator



- Increases when approaching a utility or sonde and decreases when moving away.
- Provides the highest peak reading when directly over the utility or sonde.
- Decreases when moving away from the utility.
- Can be used to distinguish between utilities when a signal transmitter is used.

Audible response

To assist in the pinpointing process, the audio output automatically adjusts over the peak reading to provide a narrower response.



Mark the position of a utility with marker paint, pegs, flags or something similar. Never drive pegs into the ground over the utility!

- ☞ The signal strength indicators do not indicate the size, depth or type of a utility.
- ☞ To ascertain an estimated depth of the utility, use a signal transmitter or a sonde. Refer to "6 Estimating Depth and Current of a Utility".

5.2 How to Trace a Utility

Tracing process

1. Pinpoint a utility by finding the peak reading. The peak reading is found when the locator is positioned directly over a utility and at 90° to it.

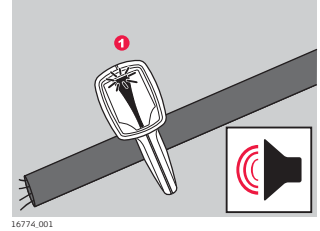

2. Rotate the Locator around its axis until the signal strength indicators are at a minimum.

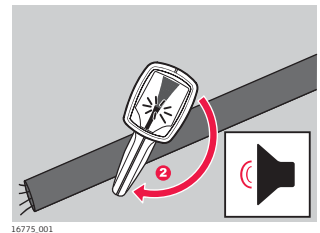

3. When the signal strength indicators are at a minimum, the blade of the locator is in line with the utility and indicates its direction.

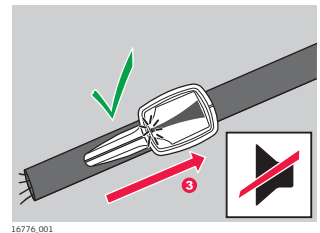

4. Trace the route of the utility by repeating the following process:
 - Pinpoint the utility.
 - Determine the direction of the utility.
 - Follow the direction of the utility.

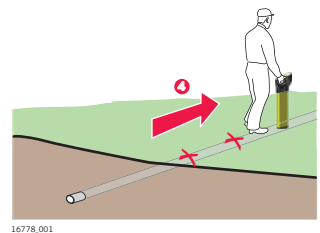

5.3 How to Conduct a Sweep Search

Sweep Search Process

Before the sweep search, define the work area to be excavated and inspect this area for signs of buried utilities, such as:

- Recent trenching
- Buried utility marker posts
- Overhead lines that run down poles and underground
- Access chamber covers

1. Set the locator to Power mode.

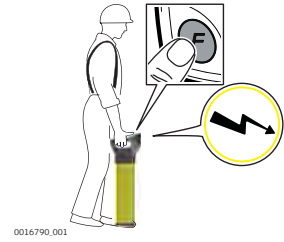

- ➔ Ensure that the locator is held upright and close to the ground. Take care not to swing the locator.

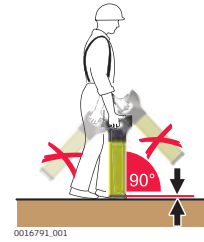

2. Cross the site from left to right until the defined area is covered.

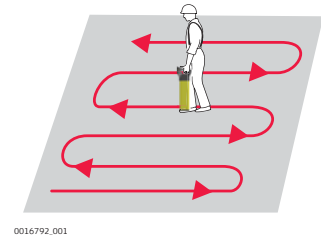

3. Turn through 90 ° and repeat the process.

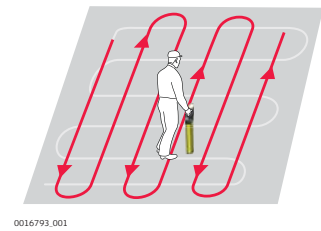

4. Pinpoint a utility by finding the peak reading. The peak reading is found when the locator is positioned directly over a utility and at 90° to it. Mark the position of a utility with marker paint, pegs, flags or something similar.

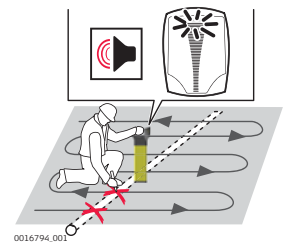

- ➔ Never drive pegs into the ground over the utility!
 - ➔ Activate the Hazard Zone alert to indicate the presence of buried utilities which may be close to the surface.

5. Set the locator to Radio mode and repeat the sweep search process. Continue with this process until either a signal is detected or you are satisfied that the area has been adequately tested.

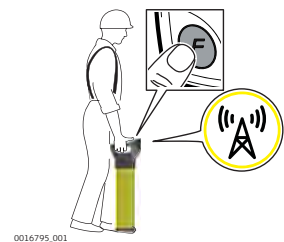



To conduct a one-step Sweep Search process or to provide a fast scan for large work areas, the locator can be used in Auto mode. To obtain an improved definition of a detected utility, use the locator in an individual mode.

5.4

Using the Transmitter in Induction Mode

5.4.1

General Information

Induction mode

Induction is a quick and simple way to apply a signal to a utility without the need to make any physical connection to it. The transmitter uses an internal aerial to transmit the signal to the utility.

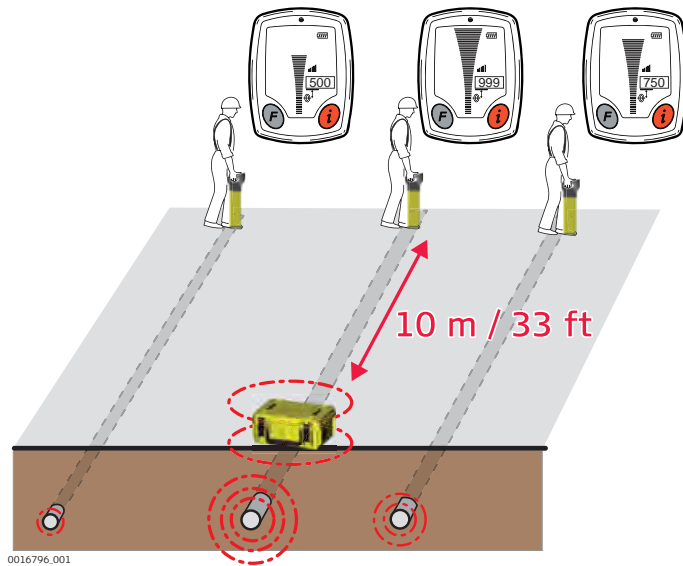

Work at least 10 m/33 ft away from the transmitter to avoid airborne signals. Reposition the Transmitter if necessary.



Coupling efficiency is best at 33 kHz.



The signal can also apply itself to other utilities within close proximity to the transmitter, depending on their depth and direction.



To increase the battery life and to reduce the possibility that the signal is applied to adjacent utilities, reduce the signal output.



The Numeric Peak Indicator can be used to indicate multiple utilities or to assist tracing. The utility with the maximum value is typically the one closest to the transmitter or the one directly connected to.

Standard process for Induction mode

1. Turn on the transmitter.
 Ensure that any connection cables or accessories are disconnected and the battery level is adequate.



13267.001

2. Select the required power output and frequency.

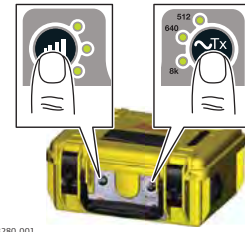

3. Place the transmitter over the utility with the arrows running in line with the suspected direction of the utility. The internal aerial directly induces the tracing signal onto the utility.

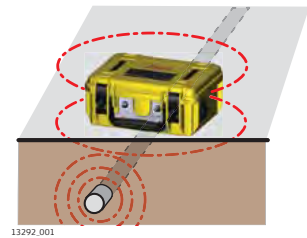

4. Set the locator to the required Signal Transmitter frequency.

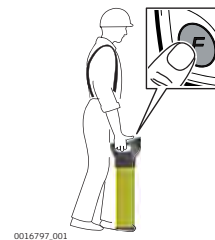

5. Using the Sweep Search process, search the work area until either a signal is detected or you are satisfied that the area has been adequately tested. Refer to "5.3 How to Conduct a Sweep Search". Trace a utility as required. Refer to "5.2 How to Trace a Utility".

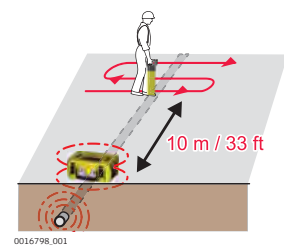

- ☞ Maintain a distance of 10 m / 33 ft from the transmitter to avoid airborne signals and a decline in the search process. Reposition the transmitter if required.

5.4.2

Induction Mode: Nulling-Out Method

Nulling-Out method

Use the Nulling-Out method to confirm that the locator and transmitter are on the same utility or to identify hidden utilities in close proximity to each other.

- ☞ The transmitter and locator need to be set for use in induction mode. Refer to "Standard process for Induction mode".

1. Position the locator over the utility with the highest numeric signal strength.

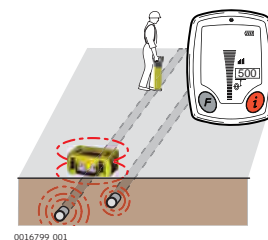

- To confirm that the transmitter and the locator are on the same utility, place the signal transmitter upright and directly over the utility.

☞ Either the speaker or the connection socket should be on the ground.

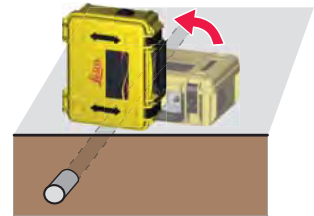

13308.001

- If the transmitter and the locator are on the same utility, the Numeric Peak Indicator on the locator significantly decreases.

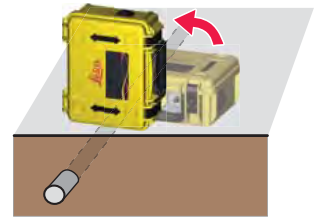

13308.001

☞ The Numeric Peak Indicator on the locator can be used to correct the position of the transmitter. Slightly move the transmitter left or right over the utility until the locate screen of the locator shows the lowest reading. It is possible to obtain the value "000".

- Using the Sweep Search process, search the work area to identify previously hidden utilities.

☞ Pinpoint and trace utilities until you are satisfied that the area has been adequately tested.

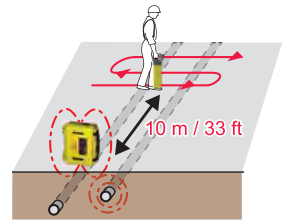

0016800.001

5.4.3

Induction Mode: Parallel-Sweep Method

Parallel-Sweep method

Use the Parallel-Sweep method to cover a large area or to verify the presence of utilities before using the standard process for induction mode.

☞ Two people are required for this process: one for operating the locator and one for operating the transmitter.

☞ Set the transmitter and locator to 33 kHz.

- Person operating the transmitter:** Hold the transmitter close to the ground with the arrows on the lid vertical and with the lid facing the person who operates the locator.

Person operating the locator:

Position the locator at a minimum distance of 10 m/33 ft away from the transmitter.

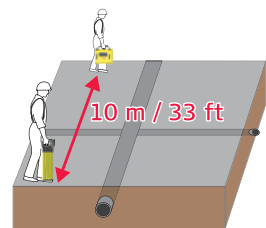

0016975.001

2. **Both persons:**
Start walking parallel to each other.
 - ☞ The tracing signal is induced directly onto the utility and indicated on the locator.

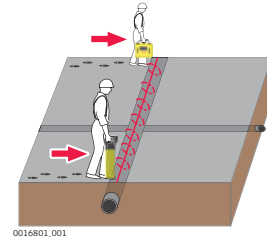

3. In the presence of a detectable utility, the locator emits a tone and the signal strength indicators rise and fall as you pass over the utility. Return to the position where the Locate screen shows a peak reading. Mark the position of a utility with marker paint, pegs, flags or something similar.
 - ☞ Never drive pegs into the ground over the utility!
 - ☞ To trace a specific utility, use the pinpointing and tracing methods. Refer to "5.1 How to Pinpoint a Utility" and "5.2 How to Trace a Utility".

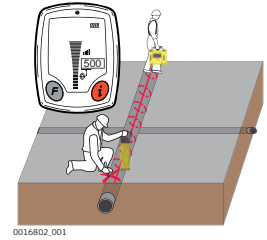

4. Turn through 90 ° and repeat the process.

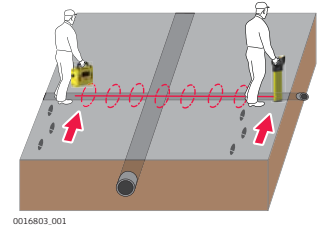

- ☞ Pinpoint and trace utilities until you are satisfied that the area has been adequately tested.

5.4.4

Induction Mode: Radial-Sweep Method

Radial-Sweep method

Use the Radial-Sweep method to discover utilities coming from a known point such as a telecommunications chamber.

- ☞ Two people are required for this process: one for operating the locator and one for operating the transmitter.
- ☞ Set the transmitter and locator to 33 kHz.

1. **Person operating the transmitter:**
Hold the transmitter close to the ground with the arrows on the lid vertical and with the lid facing the person who operates the locator.
Person operating the locator:
Position the locator at a minimum distance of 10 m/33 ft away from the transmitter.

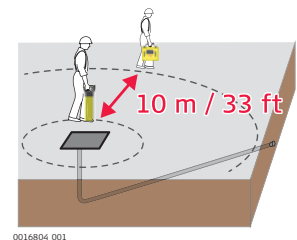

2. **Both persons:**
Start walking parallel to each other, circling the target area.

☞ The tracing signal is induced directly onto the utility and indicated on the locator.

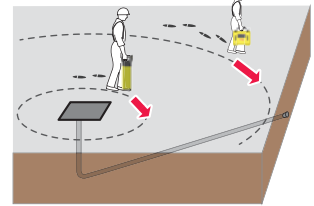

3. In the presence of a detectable utility, the locator emits a tone and the signal strength indicators rise and fall as you pass over the utility. Return to the position where the Locate screen shows a peak reading. Mark the position of a utility with marker paint, pegs, flags or something similar.

☞ Never drive pegs into the ground over the utility!

☞ To trace a specific utility, use the pinpointing and tracing methods. Refer to "5.1 How to Pinpoint a Utility" and "5.2 How to Trace a Utility".

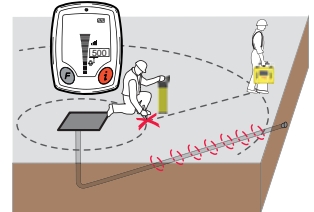

☞ Pinpoint and trace utilities until you are satisfied that the area has been adequately tested.

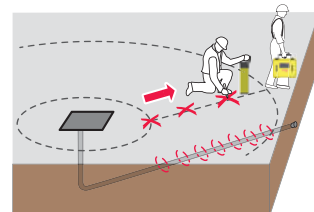

5.5

Using the Transmitter in Connection Mode

5.5.1

General Information

Connection mode

Connection mode is the most efficient way to apply a signal to a utility. The cable set of the transmitter or any of the available accessories are connected to the utility which is to be traced or identified.

- ☞ Whenever possible, use the transmitter in connection mode, especially for taking a depth reading.
- ☞ The Numeric Peak Indicator can be used to indicate multiple utilities or to assist tracing. The utility with the maximum value is typically the one connected to.
- ☞ The black connection cable can be connected to other metallic structures which go into the ground, such as iron grids or metal covers of access chambers.
- ☞ In dry conditions it may be necessary to add water around the earth point to get a good connection.
- ☞ When using the connection cable set, examine the connection points and remove contamination if a continuous audible output is not achieved.

- ☞ An extension cable is available to extend either the red or black cables on the connection cable set.
- ☞ Reducing the signal output helps to extend the battery life and to reduce the amount of signal applied to adjacent utilities.

5.5.2

Direct Connection Mode

Using the transmitter in Direct Connection mode

1. Plug the transmitters cable set into the connection socket.



2. Ensuring that no utilities are below, push the Earth Pin into the ground and connect the black cable to the Earth Pin.

- ☞ For more safety, we recommend pushing the Earth pin into the ground at an angle of 45 degrees.

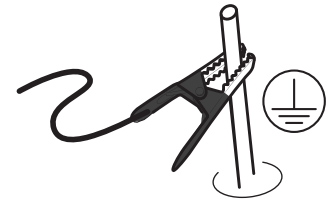

- ☞ For best performance, position the Earth pin and black cable at 90 degrees to the suspected direction of the utility.

3. Connect the red cable to the utility.

- ☞ Never connect the red cable directly to an electrical cable!

- ☞ Connecting the red cable to the metal framework of earth-bonded electrical installations such as street lights, pumps or motorised gate housings, improves the detectability of low-loaded electrical cables. For best performance, connect to bare metal.

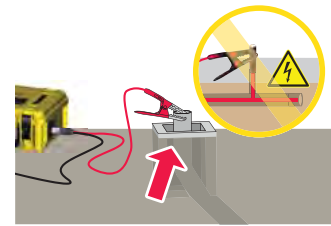

4. Turn on the transmitter.

- ☞ Ensure that the Connection Mode LED indicator is on and the battery level is adequate.

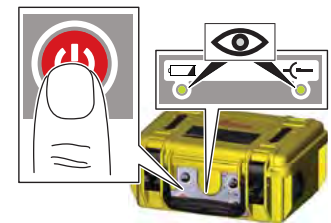

- Select the required frequency and power output.
To indicate that the tracing signal reaches a good level, the Power Output LED indicator and the audible tone change from pulsed to continuous.

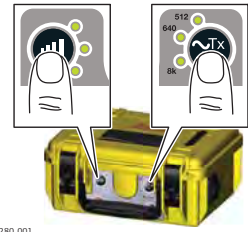

- Set the locator to the required Signal Transmitter frequency.

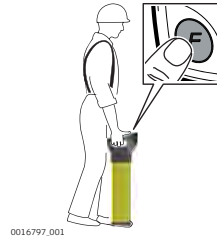

- At a distance of 5 m (16 ft) to the connection point, circle around the connection point.

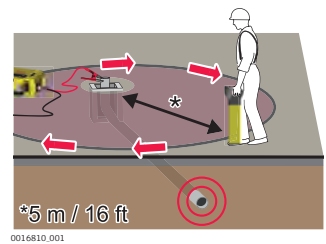

- In the presence of a detectable utility, the locator emits a tone and the signal strength indicators rise and fall as you pass over the utility. Return to the position where the Locate screen shows a peak reading. Mark the position of a utility with marker paint, pegs, flags or something similar.

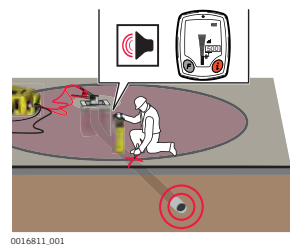

- ☞ Never drive pegs into the ground over the utility!
- ☞ To trace a specific utility, use the pinpointing and tracing methods. Refer to "5.1 How to Pinpoint a Utility" and "5.2 How to Trace a Utility".

- ☞ Pinpoint and trace utilities until you are satisfied that the area has been adequately tested.

5.6 How to Use the Trace Rod

5.6.1 General Information

Description

The Trace Rod is a utility tracer enabling small diameter non-conductive pipes, ducts, conduit or drains to be traced. It can be used in Line mode to find the route of the duct or Sonde mode to find a blockage.

Description of components

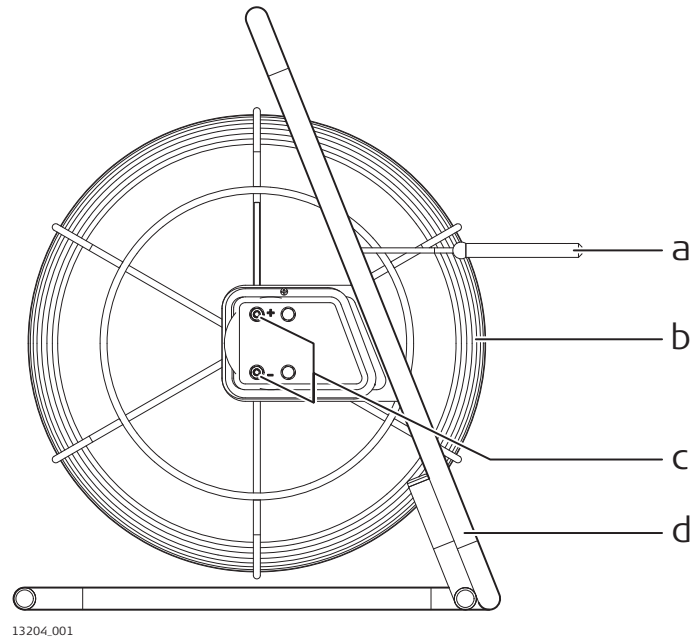

- a) **Sonde**
Using Sonde mode, the sonde helps to pinpoint the end point of the trace rod.
- b) **Line**
Flexible, glass-fibre sheathed rod, which incorporates copper wires to conduct the signal.
Using Line mode, the rod helps to trace the route of a utility.
- c) **Connection terminals**
Used to connect to the signal transmitter.
- d) **Frame**
Houses the flexible rod. Can be used in both vertical (as in illustration) and horizontal orientation.

5.6.2

Locating a Utility Using the Trace Rod

Using the trace rod in Line mode

1. Insert the rod into the pipe until the desired length is in place.

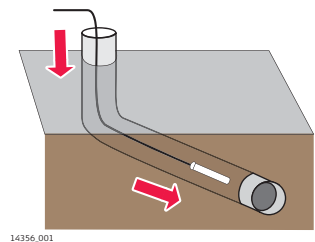

2. Plug the transmitters cable set into the connection socket.



3. Ensuring that no utilities are below, push the Earth Pin into the ground and connect the black cable to the Earth Pin.

☞ For more safety, we recommend pushing the Earth pin into the ground at an angle of 45 degrees.

☞ For best performance, position the Earth pin and black cable at 90 degrees to the suspect direction of the utility.

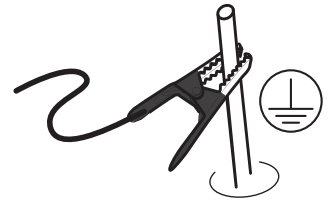

14343.001

4. Connect the red cable to the positive (+) terminal on the trace rod.

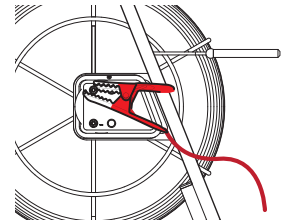

14537.001

5. Turn on the transmitter.

☞ Ensure that the Connection Mode LED indicator is on and the battery level of the transmitter is adequate.

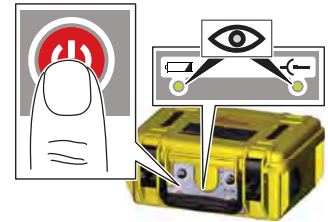

13279.001

6. Select the required frequency and power output.

To indicate that the tracing signal reaches a good level, the Power Output LED indicator and the audible tone change from pulsed to continuous.

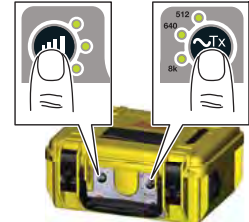

13280.001

7. Set the locator to the required Signal Transmitter frequency.

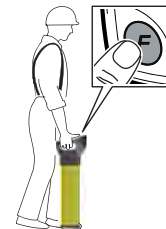

0016797.001

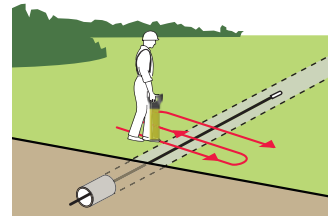

8. Sweep the area until a signal is detected. Pinpoint and trace the utility.

☞ Use the Numeric Peak Indicator to identify the exact position of the rod. The position is typically indicated by the maximum value.



0016812.001

Using the trace rod in Sonde mode

-  For ease of use practice the process above ground.
-  For ease and convenience mark the ground every 3 to 4 metres.

1. Insert the rod into the pipe, duct or conduit until the desired length is in place.

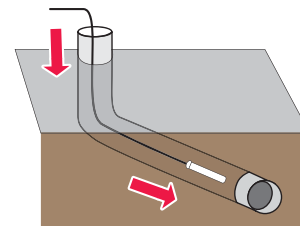

14356.001

2. Plug the transmitters cable set into the connection socket.



14341.001

3. Connect the red cable to the positive (+) terminal on the trace rod. Connect the black cable to the negative (-) terminal.

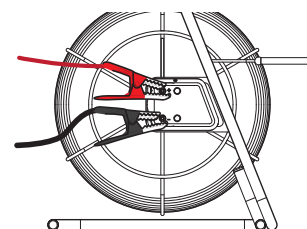

14359.001

4. Turn on the transmitter.



Ensure that the Connection Mode LED indicator is on and the battery level of the transmitter is adequate.

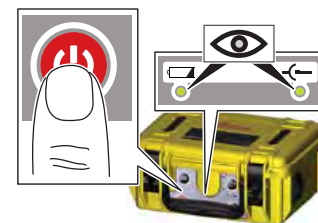

13279.001

5. Select the required frequency and power output.
To indicate that the tracing signal reaches a good level, the Power Output LED indicator and the audible tone change from pulsed to continuous.

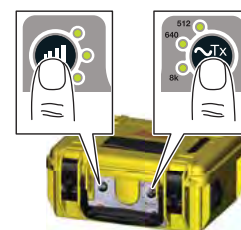

13280.001

6. Set the locator to the required Signal Transmitter frequency.

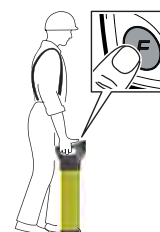

0016797.001

- Walk in line with the suspected direction of travel observing the display. The signal strength indicator rises and falls as you pass over the ghost signal at the back of the sonde, the peak signal directly over the sonde and the ghost signal at the front. The Numeric Peak Indicator displays its highest value when detecting the peak signal.

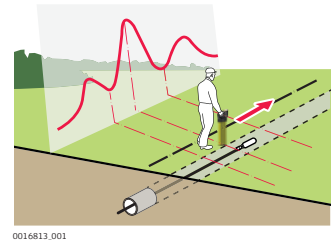

0016813_001

- Retrace your steps and position the locator directly over the peak signal. Move the locator left and right until the highest numeric reading is obtained. This reading indicates the precise location of the sonde. Pinpoint and trace the utility.

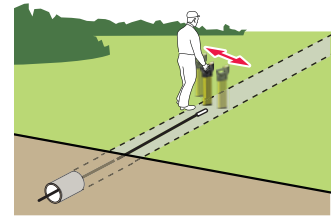

0016814_001

5.7

How to Use the Transmitter Clamps

5.7.1

General Information

Description

A Transmitter Clamp provides a safe technique of applying a signal to utilities such as telecom cables, electric cables, etc. It is connected to the Transmitter and then clipped around the utility. Supply is not interrupted by the applied signal.

Description of components

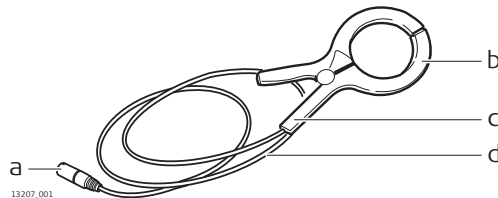

- Transmitter plug connector
- Jaws
- Handle
- Cable

5.7.2

Using a Transmitter Clamp to connect to Cable Utilities

Connecting to a cable utility

- Connect the plug of the transmitter clamp to the transmitter.



14342_001

2. Open the jaws of the transmitter clamp and place it around the utility to be traced.



Ensure that the jaws are fully engaged.

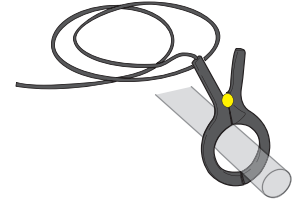

14438_001

3. Turn on the transmitter.



Ensure that the battery level of the transmitter is adequate.

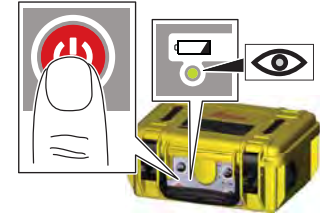

13268_001

4. Select the required frequency and power output.



For compatible frequencies check the type plate of the transmitter clamp.

To indicate that the tracing signal reaches a good level, the Power Output LED indicator and the audible tone change from pulsed to continuous.

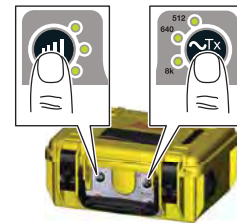

13280_001

5. Set the locator to the required Signal Transmitter frequency.

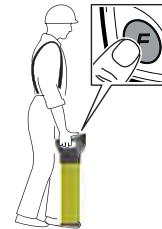

0016797_001

6. Trace the route of the utility. Refer to "5.2 How to Trace a Utility".

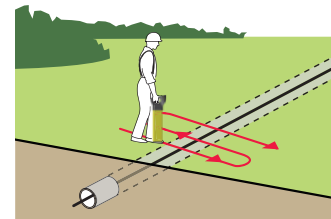

0016815_001

5.8

How to Use the Property Plug Connector

5.8.1

General Information

Description

The Property Plug Connector provides a safe technique of applying a traceable signal to live electricity cables. The applied signal does not interrupt mains supply and the risk of serious injury is greatly reduced.

Description of components

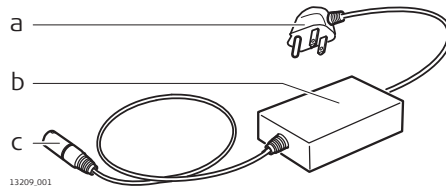

- a) Mains plug connector
- b) In-line isolator
- c) Transmitter plug connector

5.8.2

Locating a Utility Using the Property Plug Connector

Using the property plug connector

1. Connect the property plug connector to the transmitter.



2. Connect the property plug connector to a live mains outlet.

☞ Ensure that the mains connection is switched on and live.

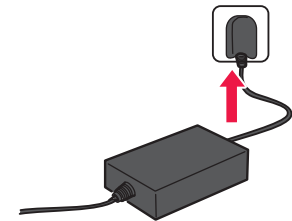

3. Turn on the transmitter.

☞ Ensure that the battery level of the transmitter is adequate.

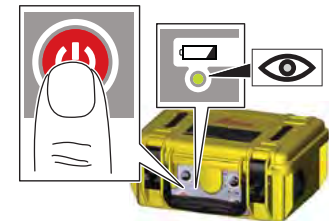

4. Select the required frequency and power output.

☞ Ensure that the frequency output of the transmitter is comparable to that of the property plug connector. Check the type plate of the property plug connector for the frequency rating.

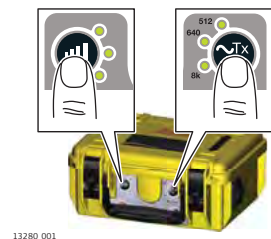

To indicate that the tracing signal reaches a good level, the Power Output LED indicator and the audible tone change from pulsed to continuous.

- Set the locator to the required Signal Transmitter frequency.

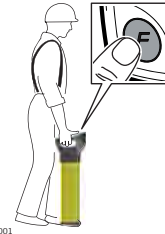

0016797.001

- Trace the length of the utility. Refer to "5.2 How to Trace a Utility".

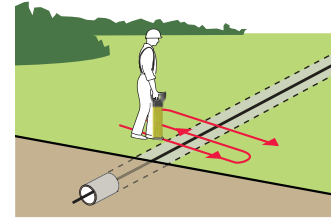

0016815.001

5.9 How to Use the Sondes

5.9.1 General Information

Description

The sondes are signal transmitters used to trace pipes, ducts, conduit or drains. A sonde can be attached to a range of equipment including drain rods, boring tools and inspection cameras. It is powered by its own battery supply, so unlike other accessories this does not require a connection to the transmitter.

The signal pattern transmitted from a sonde is different to that which is radiated from a utility and requires tracing in its own unique method. The sonde transmits a peak signal over its main body, with a ghost signal at its front and back.

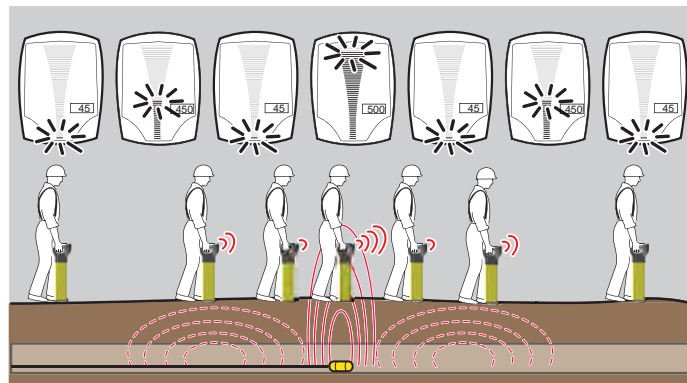

0016816.001



The Locator features a Numeric Peak Indicator which is used to identify the peak reading. Refer to "3.1 Display Panel Overview".

How to trace a utility using a sonde





For ease of use practice the process above ground.

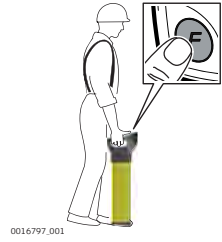

For ease and convenience mark the ground every 3 to 4 metres.

1. Set the locator and sonde to the same frequency and verify their performance.



2.  Once the function of the sonde has been verified, connect it to drain rods or other means of guiding it. Insert the sonde into the pipe, duct, conduit or drain.

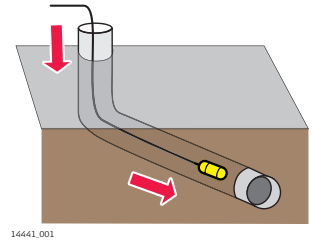

3. Walk in line with the suspected direction of travel observing the display. The signal strength indicator rises and falls as you pass over the ghost signal at the back of the sonde, the peak signal over the sonde and the ghost signal at the front. The Numeric Peak Indicator displays its highest value when detecting the peak signal.

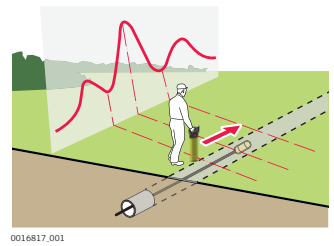

4. Retrace your steps and position the locator directly over the peak signal. Move the locator left and right until the highest numeric reading is obtained. This reading indicates the location of the sonde.

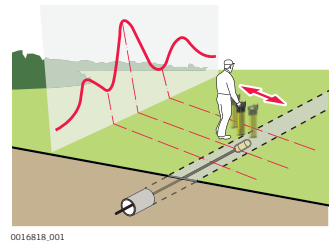

6

Estimating Depth and Current of a Utility

6.1

Utility Line Depth

Taking a depth reading

☞ For utility line depth, the locator needs to be used in conjunction with a signal transmitter. Refer to "5.4 Using the Transmitter in Induction Mode" and "5.5 Using the Transmitter in Connection Mode".

1. Set the locator to the required Signal Transmitter frequency.

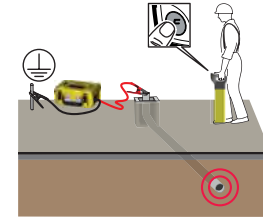

0016819.001

2. Position the locator directly over and at 90° to the direction of the utility.

☞ Ensure that the locator foot is directly on the ground.

☞ Hold the locator upright and take care not to move it.

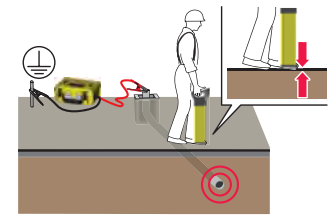

0016820.001

3. Press and release the Depth Estimation key.

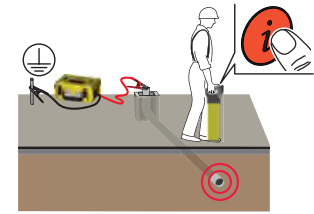

0016821.001

4. The Line Depth screen displays the measured depth.

DD130 series: The measured current (mA) is subsequently displayed.

☞ Lift the locator off the ground by approximately 15 cm/6 in and take a second depth reading. This depth reading should confirm the added height.

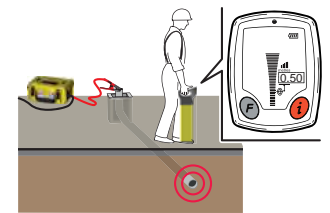

0016822.001

5. The depth is calculated as distance to the centre of the utility! Allowances should be taken into account.

Note the difference between a and b!

- a) Actual depth of the utility.
- b) Displayed depth reading: Depth to the centre of the utility.

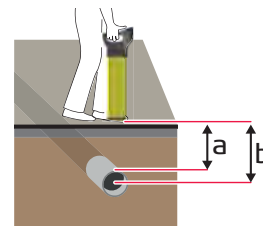

0016823.001

6.2

Sonde Depth

Taking a depth reading

☞ For sonde depth, the locator needs to be used in conjunction with a sonde. Refer to "5.9 How to Use the Sondes".

1. Set the locator to the required Sonde frequency.



0016797_001

2. Position the locator directly over and in line with the sonde.

☞ Ensure that the locator foot is directly on the ground.

☞ Hold the locator upright and take care not to move it.

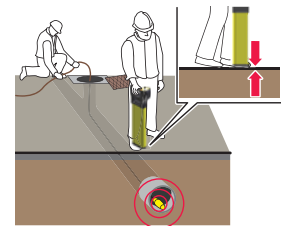

0016824_001

3. Press and hold the Depth Estimation key.

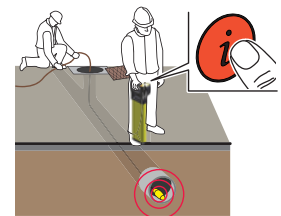

0016825_001

4. The Sonde Depth screen displays the measured depth.

☞ Lift the locator off the ground by approximately 15 cm/6 in and take a second depth reading. This depth reading should confirm the added height.

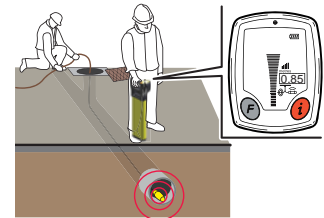

0016826_001

5. The depth is calculated as distance to the sonde within the pipe or duct! Take into account allowances for the diameter of the pipe or duct.

Note the difference between a and b!
a) Actual depth of the utility.
b) Displayed depth reading: Depth to the sonde.

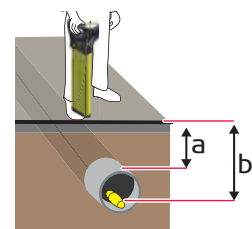









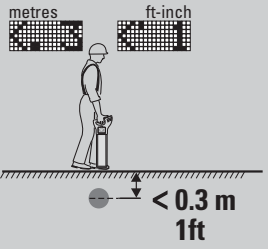

0016827_001

6.3

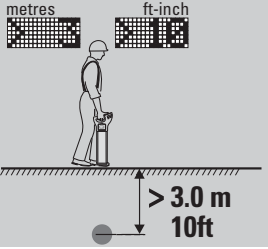
Depth Code Information

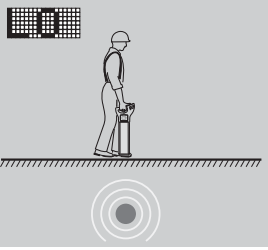
Depth Code Screens

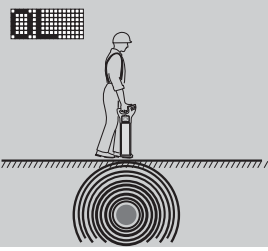
☞ If it is not possible to take a depth reading, a depth code is displayed as detailed.

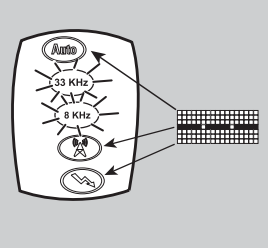
Information code	Description	Information on instrument label
 metres  ft-inch	The service is too shallow to register properly.	
 metres  ft-inch	The service is too deep.	
	The signal received by the Locator is too small to register properly.	
	The signal received by the Locator is too large to register properly.	
	Depth function not available. The Locator is set to the wrong mode for a depth reading to be taken.	

6.4

Utility Current Measurement

Current measurement to identify utilities



DD130 series only.

The Current measurement is measured in mA (milliampere) and is displayed with the utility line depth. Refer to "6.1 Utility Line Depth".

Identifying a utility

The signal transmitter is used to apply a signal (current) to the utility to be traced. The signal can couple onto additional utilities making it difficult to distinguish by conventional locating techniques.

Current measurement helps to identify the utility to which the transmitter is attached by providing the highest current reading (mA). Unlike the Numeric Peak reading, the current reading is not effected by changing depth levels.

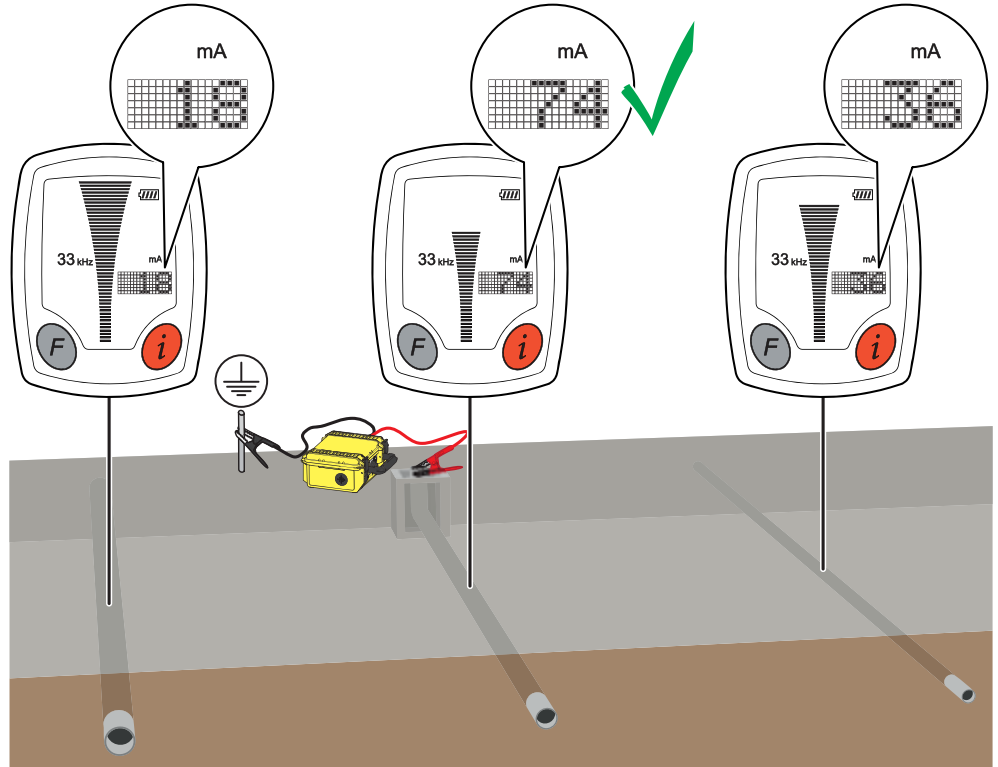

0016949_001

Identifying the utility layout and condition

The signal (current) applied by the transmitter decreases at a uniform rate as it travels along the utility. This can help to identify the utility layout and condition.

A sudden reduction in current may indicate a fault in the utility, a damage to the insulation, or a connection off the utility.

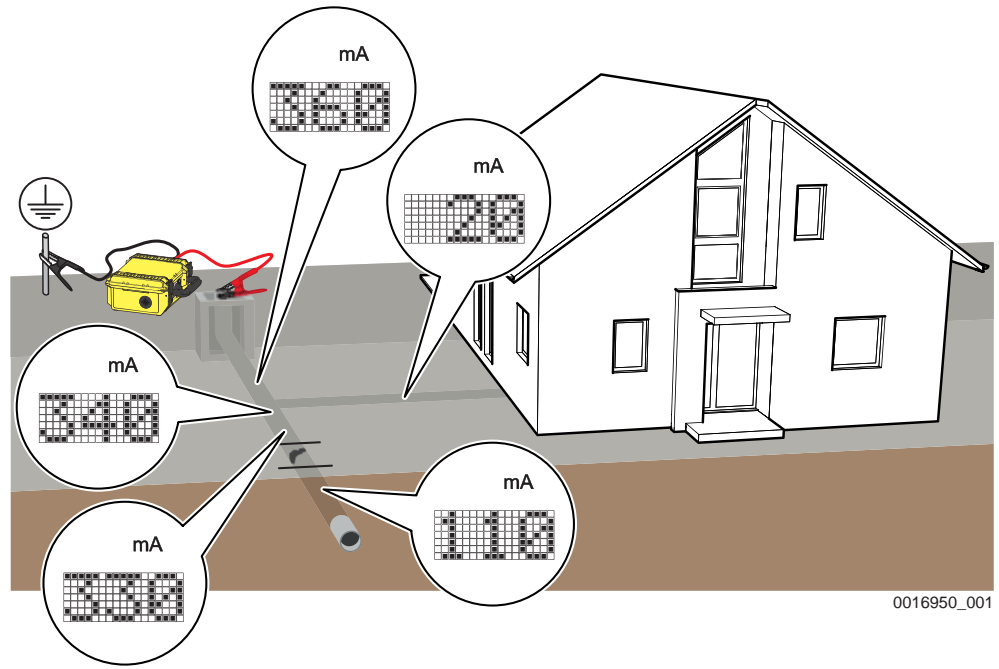

7

Connectivity

7.1

Transmitter USB Connectivity

Connecting the transmitter using USB

The signal transmitter is provided with a USB port and can be connected to a PC for one of the following reasons:

- To update software.
- To provide calibration and maintenance support.

☞ It is recommended that a battery level of greater than 50% is maintained whilst in communication with external devices.

Access to the USB port

☞ The cover of the battery compartment also serves as cover for the USB port. To maintain environmental protection open the cover only in dry conditions. Always close the cover of the battery compartment after use.

1. Unscrew the fastener of the cover.



2. Lift the cover of the battery compartment to access the USB port.

☞ For guidance on establishing a connection, follow the instructions on the external device or software. Refer to the manufacturer's instructions.



3. After disconnection, close the cover of the battery compartment and tighten the fastener.



⚠ WARNING**Short circuit of battery terminals**

If battery terminals are short circuited e.g. by coming in contact with jewellery, keys, metallised paper or other metals, the battery can overheat and cause injury or fire, for example by storing or transporting in pockets.

Precautions:

- ▶ Make sure that the battery terminals do not come into contact with metallic objects.

Use the transmitters with an authorised rechargeable Li-Ion battery pack.

8.1**Locators Batteries****Locator Batteries**

The DD120 series and DD130 series Locators are fitted with six LR6 (AA) alkaline batteries

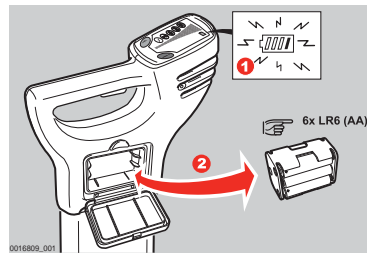
Changing the Battery

1. Replace or recharge the batteries when the battery status indicator is empty.
2. Press the release button to unlock the Battery Hatch. Remove the battery holder from the Locator.
3. Replace all batteries with six new LR6 (AA) type alkaline batteries, or remove and recharge the battery pack if rechargeable batteries are fitted.

8.2**Charging the Li-Ion Battery Pack****Charging the battery pack of the signal transmitter**

If the battery pack of the signal transmitter is low and needs to be recharged, the Low Battery LED indicator illuminates red.



The cover of the battery compartment also serves as cover for the USB port. To maintain environmental protection open the cover only in dry conditions. Always close the cover of the battery compartment after use.

1. Unscrew the fastener of the battery cover.



14472_001

2. Lift the cover of the battery compartment and remove the Li-Ion battery pack.

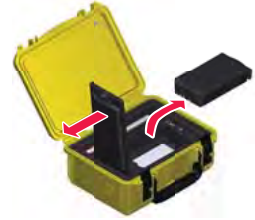

14475.001

3. Connect the charger plug into the charge jack on the battery pack.



14479.001

4. Plug the connector into a suitable power source.



The small LED next to the charge jack flashes to indicate that the battery pack is charging. When the battery pack is fully charged the LED is on solid.

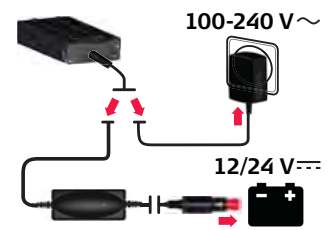

14480.001

5. When the battery pack is fully charged, disconnect the charger and reinsert the battery pack into the battery compartment.



14476.001

6. Close the cover of the battery compartment and tighten the fastener.



14473.001

8.3

Operating Principles

First-time use/ charging batteries

- The battery must be charged before using it for the first time because it is delivered with an energy content as low as possible.
- The permissible temperature range for charging is from 0 °C to +40 °C/ +32 °F to +104 °F. For optimal charging, we recommend charging the batteries at a low ambient temperature of +10 °C to +20 °C/+50 °F to +68 °F if possible.
- It is normal for the battery to become warm during charging. Using the chargers recommended by Leica Geosystems, it is not possible to charge the battery once the temperature is too high.
- For new batteries or batteries that have been stored for a long time (> three months), it is effectual to make only one charge/discharge cycle.
- For Li-Ion batteries, a single discharging and charging cycle is sufficient. We recommend carrying out the process when the battery capacity indicated on the charger or on a Leica Geosystems product deviates significantly from the actual battery capacity available.

Operation/ discharging

- The batteries can be operated from -20 °C to +55 °C/-4 °F to +131 °F.
 - Low operating temperatures reduce the capacity that can be drawn; high operating temperatures reduce the service life of the battery.
-

9 Functional Checks

9.1 Locator Health Check

Checking the function Leica Geosystems accepts no responsibility for maintenance and calibration conducted by unauthorised persons.

Locator depth test  If the depth reading deviates from known depth of the test utility or if an error code is displayed, return the locator for service.

9.2 Locator Functional Check

Checking the function Before any tests can be carried out it is vital to check the status of the unit, its batteries and basic functionality.

The following list is used to achieve this.

1. Inspection

- **Casing:** The casing should be free of significant damage.
- **Labels:** Body labels must be legible and intact. Display label must be free of damage and tears.
- **Battery hatch:** The hatch must lock into place.
- **Battery holder:** All the battery contacts and springs on the holder must be free of corrosion and the holder in good condition.
- **Battery contacts:** The battery contacts must be free of corrosion.

Once the general condition of the Locator is established the Audio Visual test can be performed.

2. Audio/Visual display test

Upon depressing the trigger the Locator should test the display and speakers by illuminating each segment in the bar display, the mode and function indicators and depth display, the battery indicator light will illuminate throughout the display test. All LCDs must be operative and an audible output must be heard.

3. Battery/Functional self check

If there is no response when the trigger is activated or the low battery illuminates (or flashes) after the Audio / Visual display test, the batteries will have to be replaced. Use alkaline batteries. Replace all of the batteries at the same time.

Checking the function The purpose of the following procedure is to verify the performance of the Locator. It is important that the test is conducted away from areas of electromagnetic interference or over buried services with a large signal radiating off them.

1. Switch the Locator on.
 2. Whilst in Power mode hold down the i Button, until the settings are displayed.
 3. Using the Function Button toggle through the settings until **EST** is displayed.
 4. Press the i Button to activate the test.
-

5. Observe the displayed output:
 - **PAS** means unit is within set tolerances.
 - **ERR** means unit is outside set tolerances and may need servicing.
-
-  • Repeat the test in a different location if the units displays **ERR**.
- The Locator will automatically repeat the function test if it fails.
- Repeated failure will indicate a faulty unit, which must be returned for service.
-

Checking depth indication (DD120, DD130)

This test can be carried out provided the depth of a service on the test area is known.

1. Switch the Locator on and ensure that it is in 33 kHz mode.
 2. Position the Locator directly over and at right angle to the service.
 3. Press and release the i Button to activate the depth measurement.
 4. Record the depth.
 5. If the depth reading deviates from the normal value or an error code is displayed, the Locator should be returned for service.
-

 **If any of these tests give no response or a significantly different response from normal, the Locator should be returned for service.**

9.3

Functional Check of the Transmitter

Checking the function





Before you carry out any tests, it is vital to check the status of the unit, its batteries and its basic functionality. To achieve this, carry out the following procedure:

 For this procedure, the cable set of the transmitter and a fully charged battery pack are required.

1. **Inspect the general condition of the transmitter.**
 - The casing should be free of significant damage.
 - The cable set should be free of damage to the cable insulation and clip shrouds. The clips should be free of corrosion.
 - Body labels must be legible and intact.
 - The cover of the battery compartment must lock into place.
 - All the battery contacts and springs of the compartment must be free of corrosion and the compartment in good condition.
 - The battery contacts must be free of corrosion.
 - The cover of the USB port must be in place and provide the required environmental protection.
 2. **Once the general condition of the transmitter is established, perform the Audio/Visual test.**
Turn on the transmitter. All LED indicators should light up and the speaker should emit a tone.
 3. **Perform a Battery check.**
Observe the Low Battery LED indicator and replace or recharge the batteries if necessary.
-

Checking the performance

The purpose of the following procedure is to verify the performance of the transmitter.

-
-  Conduct the test away from areas of electromagnetic interference or over buried utilities with a large signal radiating off them.
-
1. Plug the transmitters cable set into the connection socket.
 2. Connect the black and red cable clips together, ensuring good metal to metal contact.
 3. Press and hold the Frequency key and turn on the transmitter. Keep holding the Frequency key until the test starts.
 4. Observe the displayed output during the performance check:
Induction Mode Test: The Frequency LED indicators light up one after the other, showing the frequency on test.
Connection Mode Test: The Connection Mode LED indicator lights up. The Frequency LED indicators light up, showing the frequencies on test. The Connection Mode LED indicator turns off.
 5. After the performance check, the transmitter displays the result:
Test successful: A high-low pulsed tone is emitted three times. If the test was done with low batteries, the Low Battery LED indicator illuminates.
Test failed: A low-pitched tone is emitted. If the test was done with low batteries, the Low Battery LED indicator illuminates.
 - If the Induction Mode failed: The respective Frequency LED indicator lights up.
 - If the Connection Mode failed: The Connection Mode LED indicator and the respective Frequency LED indicator light up.
-
-  If the performance check fails, ensure that the cable set of the transmitter is fully engaged and the clips are connected.
-
-  If the performance check fails, the transmitter automatically repeats it. Repeated failure indicates a faulty unit. Return the transmitter for service.
-
-  The Signal Transmitters firmware can be updated to the latest standard using DX Office Shield. It is important that DX Office Shield is installed on a PC with Internet access. For additional information refer to <https://leica-geosystems.com>.
-

9.4

Functional Check of the Trace Rod

Checking the performance

The purpose of the following procedure is to verify the performance of the trace rod.

-
-  For this procedure, the following system components are required:
- A transmitter for generating the signal in the Sonde and Line mode tests.
 - The cable set for the transmitter.
-
1. Plug the transmitters cable set into the connection socket.
 2. Connect the red cable to the positive (+) terminal on the trace rod and the black cable to the negative (-) terminal.
 3. Turn on the transmitter.
 4. Use the Power Output key on the transmitter to adjust the power output to minimum. The transmitter should emit a constant tone.
-

5. Disconnect the black cable from the negative (-) terminal.
The transmitter should emit a pulsed tone.



If for any of these tests no output or a significantly different output is displayed, return the trace rod for service.

9.5

Functional Check of the Sonde

Checking the function

Before you carry out any tests, it is vital to check the status of the unit, its batteries and its basic functionality. To achieve this, carry out the following procedure:

1. **Inspect the general condition of the sonde.**
 - The casing should be free of significant damage.
 - The sealing ring and the screw thread should be intact.
2. **Once the general condition of the sonde is established, perform the LED test.**

Turn on the sonde. The LED indicator should light up.
3. **Perform a Battery check.**

If the LED indicator lights up faintly or if the sonde does not transmit a signal, the batteries are probably low. Replace the batteries if necessary.

Checking the performance

The purpose of the following procedure is to verify the performance of the sonde.



For this procedure, the following system components are required:

- A locator to detect the signal of the sonde.
- A work area free of utilities (as illustrated).

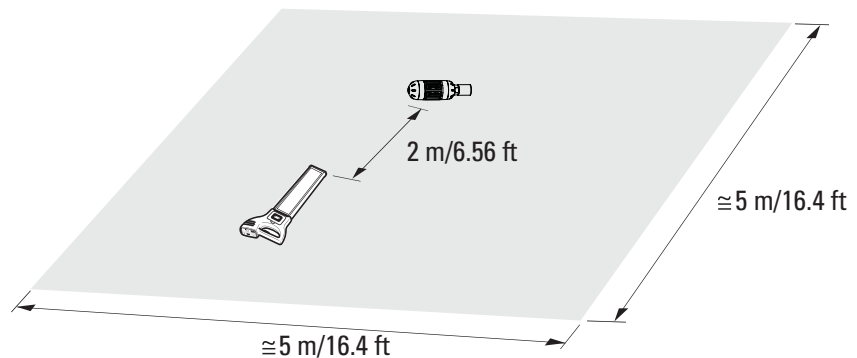

0016948_001

1. Set up the sonde for use at 33 kHz.
2. Turn on the locator. Set the locator to 33 kHz.
3. Aim the locator foot at the sonde.
 - At a distance of 2 m/6.56 ft, the signal strength indicators should display a peak reading.
4. Set up the sonde for use at 8 kHz.
5. Turn on the locator. Set the locator to 8 kHz.
6. Aim the locator foot at the sonde.
 - At a distance of 2 m/6.56 ft, the signal strength indicators should display a peak reading.



If for any of these tests no output or a significantly different output is displayed, return the sonde for service.

10 Care and Transport

10.1 Transport

Transport in the field When transporting the equipment in the field, always make sure that you carry the product in its original packaging or equivalent, and protect the equipment against shock and vibration.

Transport in a road vehicle Never carry the product loose in a road vehicle, as it can be affected by shock and vibration. Always carry the product in its container and secure it.
For products for which no container is available use the original packaging or its equivalent.

Shipping When transporting the product by rail, air or sea, always use the complete original Leica Geosystems packaging, container and cardboard box, or its equivalent, to protect against shock and vibration.

Shipping, transport of batteries When transporting or shipping batteries, the person responsible for the product must ensure that the applicable national and international rules and regulations are observed. Before transportation or shipping, contact your local passenger or freight transport company.

10.2 Storage

Product Respect the temperature limits when storing the equipment, particularly in summer if the equipment is inside a vehicle. Refer to "11 Technical Data" for information about temperature limits.

Storing Long-term battery storage is not recommended. If storage is necessary:

- Refer to "Technical Data" for information about storage temperature range.
- Remove batteries from the product and the charger before storing.
- After storage recharge batteries before using.
- Protect batteries from damp and wetness. Wet or damp batteries must be dried before storing or use.
- A storage temperature range of 0°C to +30°C/+32°F to 86°F in a dry environment is recommended to minimise self-discharging of the battery.
- At the recommended storage temperature range, batteries containing a 40% to 50% charge can be stored for up to one year. After this storage period the batteries must be recharged.
- Always try to use a 'first-in first-out' approach to minimise storage time.

10.3 Cleaning and Drying

Damp products Dry the product, the transport container, the foam inserts and the accessories at a temperature not greater than 40°C/104°F and clean them. Do not repack until everything is dry. Always close the transport container when using in the field.

Cables and plugs Keep plugs clean and dry. Blow away any dirt lodged in the plugs of the connecting cables.

11 Technical Data

11.1 Conformity to National Regulations

Conformity to national regulations

- FCC Part 15 (applicable in US)
- Hereby, Leica Geosystems AG declares that the product/s is/are in compliance with the essential requirements and other relevant provisions of the applicable European Directives.
The full text of the EU declaration of conformity is available at the following Internet address:
<http://www.leica-geosystems.com/ce>.



11.2 Transmitter Technical Data

DA series signal transmitters

Mode	Output
Induction	Up to 1 Watt max.
Connection mode	Model dependent, up to 1 Watt or 3 Watt, when connected to a buried utility with an impedance of 300 Ohms
Operating transmission frequencies	131.072 (131) kHz 32.768 (33) kHz 8.192 (8) kHz 512 Hz (DA230 series models) 640 Hz DA230 series models)
Display panel	LED Indicators: Battery low indicator Connection mode Frequency indicator Power Output indicator
Keypad	4 membrane push buttons
Audio	85 dBA @ 30 cm Induction mode: Pulsed output with a differing rate for each frequency Connection mode: Low - No output: pulsed output, differing rate for each frequency Good Connection output: constant tone, pitch dependent on power output
Battery type	7.4 V Li-Ion pack
Typical operating time 3 Watt, 1 Watt	15 hours at power level 2 connection mode
Dimensions	250 x 206 x 113 mm/9.84 x 8.11 x 4.45 inches
Weight (incl. standard accessories and batteries)	2.38 kg with Li-Ion

Mode	Output
Temperature	Operating -20°C to +50°C, -4°F to +122°F Storage -40°C to +70°C, -40°F to +158°F
Protection against water, dust and sand	Conforms to IP67 lid open or closed
Humidity	95% RH non condensing The effects of condensation are to be effectively counteracted by periodically drying out the product.
Approvals	CE, FCC

Dimensions

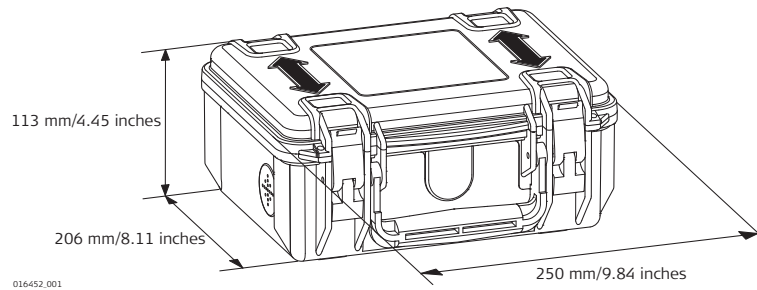

Charger

Description	A100 Lithium Ion Charger	A140 Lithium Ion Charger
Type	Li-Ion battery charger	Li-Ion battery charger
Input voltage	100 V AC-240 V AC, 50 Hz-60 Hz	12 V DC
Output voltage	12 V DC	12 V DC
Output current	3.0 A	5.0 A
Polarity	Shaft: negative, Tip: positive	Shaft: negative, Tip: positive

Battery pack

Description	D Series Lithium-Ion Battery pack
Type	Li-Ion battery pack
Input voltage	12 V DC
Input current	2.5 A
Charge time	5 hours (maximum) at 20°C

11.3

Locator Technical Data

DD120, DD130 locators

Operating frequencies

Mode	Frequency
Power	50 Hz or 60 Hz mains electrical and harmonics
Radio	15 kHz to 60 kHz
Auto	Power, Radio, 33 kHz

Mode	Frequency
Transmitter	32.768 (33) kHz
	8.192 (8) kHz
	512 Hz (DD130 series models)
	640 Hz (DD130 series models)

Depth estimation

Locator	DD120 series	DD130 series
Depth range	Line 0.3 m to 3 m	Line 0.3 m to 3 m
	Line 0.3 m to 3 m	Sonde 0.1 to 9.99 m
Depth accuracy Undistorted signal	10%	10%

General technical data

Mode	Output
Display panel	Monochrome
Keypad	2 membrane push buttons
Audio	85 dBA @ 30 cm Power, Radio and Auto mode: Continuous tone (different pitch for each mode).
	8 kHz and 33 kHz mode: All tones are different. Pulsed tone (different pitch for each mode).
	512 Hz and 640 Hz mode: Pulsed tone (different pitch for each mode).
	All tones are different.
Battery type	6 × LR6 (AA) alkaline
Typical operating time	15 hours constant use at 20 °C/68 °F
Dimensions	85 x 250 x 760 mm/3.4 x 10 x 30 inches
Weight (incl. batteries)	2.7 kg with batteries
Temperature	Operating -20 °C to +50 °C, -4 °F to +122 °F Storage -40 °C to +70 °C, -40 °F to +158 °F
Protection against water, dust and sand	Conforms to IP54
Humidity	95% RH non condensing The effects of condensation are to be effectively counteracted by periodically drying out the product.

Dimensions

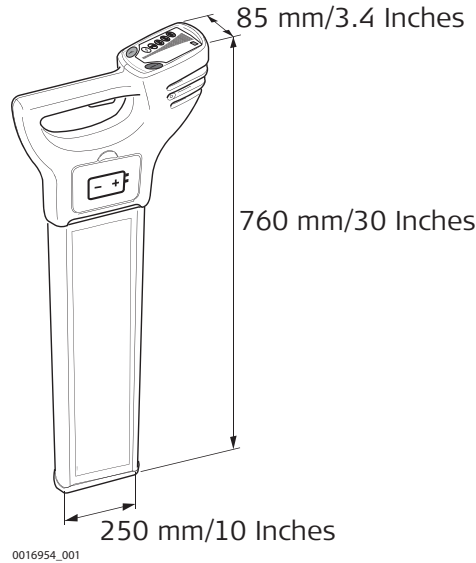

11.4

Conductive Rod Technical Data

Conductive rod

Description	Value
Typical detection range	Both modes, line and sonde: Typical 3.0 m/10 ft
Tracing distance	50 m/165 ft; 80 m/263 ft (maximum). Reel length dependant.
Operating transmission frequencies	Dependent on transmitter
Dimensions	440 x 210 x 490 mm/ 17.3 x 8.3 x 19.3 inches
Weight	50 m: 4 kg/8.8 lbs 80 m: 4.7 kg/10.4 lbs

Dimensions

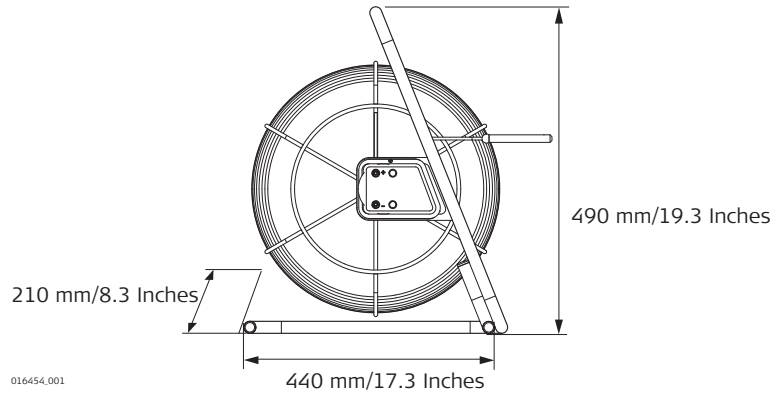

11.5

Property Plug Connector Technical Data

Property plug connector

Mode	Output
Operating transmission frequencies	32.768 (33) kHz

Mode	Output
Temperature	Operating -20°C to +50°C, -4°F to +122°F Storage -40°C to +70°C, -40°F to +158°F
Protection against water, dust and sand	IP54 (IEC 60529) Dust-protected
Humidity	95% RH non condensing The effects of condensation are to be effectively counteracted by periodically drying out the product.
Dimensions	100 x 80 mm/3.9 x 3.1 inches
Weight	0.15 kg/0.3 lbs

Dimensions

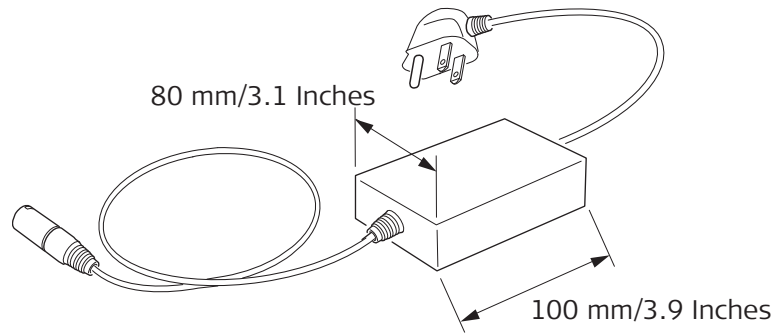

World Frequency Zones

North America

Canada	120 V / 60 Hz
United States	120 V / 60 Hz
Mexico	120 V / 50 Hz, 60 Hz

Central America

Bahamas	115 V / 60 Hz
Barbados	115 V / 50 Hz
Belize	110-220 V / 60 Hz
Bermuda	115 V / 60 Hz
Costa Rica	120 V / 60 Hz
Cuba	115-120 V / 60 Hz
Dominican Republic	110-220 V / 60 Hz
El Salvador	120-240 V / 60 Hz
Guatemala	115-230 V / 60 Hz
Haiti	110-220 V / 60 Hz
Honduras	110-220 V / 60 Hz
Jamaica	220 V / 50 Hz
Netherland Antilles	110-127 V / 50 Hz
Nicaragua	120 V / 60 Hz
Panama	120 V / 60 Hz
Puerto Rico	120 V / 60 Hz
Trinidad & Tobago	115-230 V / 60 Hz
Virgin Islands	120 V / 60 Hz

South America

Argentina	230 V / 50 Hz
Bolivia	110 V / 50 Hz
Brazil	110-127-220 V / 60 Hz
Chile	220 V / 50 Hz
Colombia	110-220 V / 60 Hz
Ecuador	110-220 V / 60 Hz
French Guiana	220 V / 50 Hz
Guyana	110-240 V / 60 Hz
Paraguay	220 V / 60 Hz
Peru	220 V / 60 Hz
Surinam	110-127 V / 60
Uruguay	220 V / 50 Hz
Venezuela	120-240 V / 60 Hz

Australia, Oceania

Australia	240 V / 50
Fiji Islands	240 V / 50
New Zealand	230 V / 50 H
Solomon Island	240 V / 50
Tonga	230 V / 50 H

Europe

Albania	230 V / 50 Hz
Austria	230 V / 50 Hz
Belgium	230 V / 50 Hz
Belarus	230 V / 50 Hz
Croatia	230 V / 50 Hz
Cyprus	240 V / 50 Hz
Czech Republic	230 V / 50 Hz
Denmark	230 V / 50 Hz
Estonia	230 V / 50 Hz
Finland	230 V / 50 Hz
France	230 V / 50 Hz
Germany	230 V / 50 Hz
Greece	230 V / 50 Hz
Hungary	230 V / 50 Hz
Iceland	230 V / 50 Hz
Ireland	230 V / 50 Hz
Italy	230 V / 50 Hz
Latvia	230 V / 50 Hz
Lithuania	230 V / 50 Hz
Luxemburg	230 V / 50 Hz
Moldavia	230 V / 50 Hz
Netherlands	230 V / 50 Hz
Norway	230 V / 50 Hz
Poland	230 V / 50 Hz
Portugal	230 V / 50 Hz
Romania	230 V / 50 Hz
Russia	230 V / 50 Hz
Slovakia	230 V / 50 Hz
Slovenia	230 V / 50 Hz
Spain	230 V / 50 Hz
Sweden	230 V / 50 Hz
Switzerland	230 V / 50 Hz
Ukraine	230 V / 50 Hz
United Kingdom	230 V / 50 Hz

Africa

Algeria	127-220 V / 50 Hz
Angola	220 V / 50 Hz
Benin	220 V / 50 Hz
Botswana	220 V / 50 Hz
Burkina Faso	220 V / 50 Hz
Burundi	220 V / 50 Hz
Cameroon	127-220 V / 50 Hz
Central Africa Republic	220 V / 50 Hz
Chad	220 V / 50 Hz
Congo	220 V / 50 Hz
Dahomey	220 V / 50 Hz
Egypt	220 V / 50 Hz
Ethiopia	220 V / 50 Hz
Gabon	220 V / 50 Hz
Gambia	230 V / 50 Hz
Ghana	240 V / 50 Hz
Ivory Coast	220 V / 50 Hz
Kenya	240 V / 50 Hz
Lesotho	220-240 V / 50 Hz
Liberia	120 V / 60 Hz
Libya	115-220 V / 50 Hz
Malawi	230 V / 50 Hz
Mali	220 V / 50 Hz
Mauritania	220 V / 50 Hz
Mauritius	230 V / 50 Hz
Marocco	127-220 V / 50 Hz
Mozambique	220 V / 50 Hz
Namibia	220 V / 50 Hz
Niger	220 V / 50 Hz
Nigeria	230 V / 50 Hz
Rwanda	220 V / 50 Hz
Senegal	110 V / 50 Hz
Sierra Leone	230 V / 50 Hz
Somalia	220 V / 50 Hz
South Africa	220-240 V / 50 Hz
Sudan	240 V / 50 Hz
Swaziland	220 V / 50 Hz
Tanzania	230 V / 50 Hz
Togo	127-220 V / 50 Hz
Tunesia	127-220 V / 50 Hz
Uganda	240 V / 50 Hz
Zaire	220 V / 50 Hz
Zambia	220 V / 50 Hz
Zimbabwe	220 V / 50 Hz

Asia

Abu Dhabi	230 V / 50 Hz
Afghanistan	220 V / 50 Hz
Armenia	220 V / 50 Hz
Azerbaijan	220 V / 50 Hz
Bahrain	110-230 V / 50 Hz, 60 Hz
Bangladesh	230 V / 50 Hz
Brunei	240 V / 50 Hz
Cambodia	220 V / 50 Hz
China	220 V / 50 Hz
Georgia	220 V / 50 Hz
Hong Kong	220 V / 50 Hz
India	230-250 V / 50 Hz, 60 Hz
Indonesia	127-220 V / 50 Hz
Iran	220 V / 50 Hz
Iraq	220 V / 50 Hz
Israel	230 V / 50 Hz
Japan	110-220 V / 50 Hz, 60 Hz
Jordan	220 V / 50 Hz
Kazakhstan	220 V / 50 Hz
Kirgizstan	220 V / 50 Hz
Korea (North)	220 V / 50 Hz
Korea (South)	110-220 V / 60 Hz
Kuwait	240 V / 50 Hz
Laos	220 V / 50 Hz
Lebanon	110-220 V / 50 Hz
Malaysia	240 V / 50 Hz
Myanmar	240 V / 50 Hz
Oman	240 V / 50 Hz
Pakistan	230 V / 50 Hz
Philippines	110-220 V / 60 Hz
Qatar	240 V / 50 Hz
Saudi Arabia	127-220 V / 50 Hz
Singapore	230 V / 50 Hz
Sri Lanka	230 V / 50 Hz
Syria	220 V / 50 Hz
Taiwan	110-220 V / 60 Hz
Tajikistan	220 V / 50 Hz
Thailand	220 V / 50 Hz
Turkey	220 V / 50 Hz
Turkmenistan	220 V / 50 Hz
United Arab Emirates	220 V / 50 Hz
Uzbekistan	220 V / 50 Hz
Vietnam	110-220 V / 50 Hz
Yemen	220 V / 50 Hz

873882-1.0.0en

Original text

Published in Switzerland

© 2018 Leica Geosystems AG, Heerbrugg, Switzerland

Leica Geosystems AG

Heinrich-Wild-Strasse
CH-9435 Heerbrugg
Switzerland
Phone +41 71 727 31 31

www.leica-geosystems.com



- when it has to be **right**

Leica
Geosystems